

© EILERSEN 2019  
N. EILERSEN A/S  
FABRIKSVEJ 2  
DK-5485 SKAMBY  
DENMARK  
TEL +45 6485 1008  
EILERSEN.EU



eilersen

If your sofa is going  
to be the centrepiece  
of your home, shouldn't  
you have it exactly as  
you want it?  
2019

2019



© EILERSEN 2019  
N. EILERSEN A/S  
FABRIKSVEJ 2  
DK-5485 SKAMBY  
DENMARK  
TEL +45 6485 1008  
EILERSEN.EU



eilersen®

If your sofa is going  
to be the centrepiece  
of your home, shouldn't  
you have it exactly as  
you want it?  
2019

2019





© EILERSEN 2019  
N. EILERSEN A/S  
FABRIKSVEJ 2  
DK-5485 SKAMBY  
DENMARK  
TEL +45 6485 1008  
EILERSEN.EU



eilersen®

If your sofa is going  
to be the centrepiece  
of your home, shouldn't  
you have it exactly as  
you want it?  
2019

2019



© EILERSEN 2019  
N. EILERSEN A/S  
FABRIKSVEJ 2  
DK-5485 SKAMBY  
DENMARK  
TEL +45 6485 1008  
EILERSEN.EU



eilersen®

If your sofa is going  
to be the centrepiece  
of your home, shouldn't  
you have it exactly as  
you want it?  
2019



2019





skabelon til stikninger  
99 Ryg 9.

If your sofa is going to be the centrepiece of your home, shouldn't you have it exactly as you want it?





# Every couch from Eilersen is built by hand. We encourage you to take advantage of that.

Make it bigger or smaller. Choose a softer pillow, change the fabric, or adjust the width. With My Eilersen, you can customize your couch to match your mood and temperament. If it's going to be the centrepiece of your home, shouldn't you have it exactly the way you want it?







The Greeks invented the golden section, but few modernist furniture makers have taken it further. Every couch in this catalogue is built on the same principle of square, one and a half square and double squares. Because nothing says Eilersen more than those smooth, wide, low lines.

Our look and feel may seem international, but the inheritance is downright Scandinavian.



Skilled hands and first-rate materials combine to create the ultimate in upholstered furniture. We Scandinavians like our pinewood to grow slowly for a minimum of tension. We like adhesives to be water-based and our springs to stay fit and non-creaking. We even have standards for the uniformity of staples and threads.

To obtain an  
Eilersen is to enter a  
lifelong relationship.



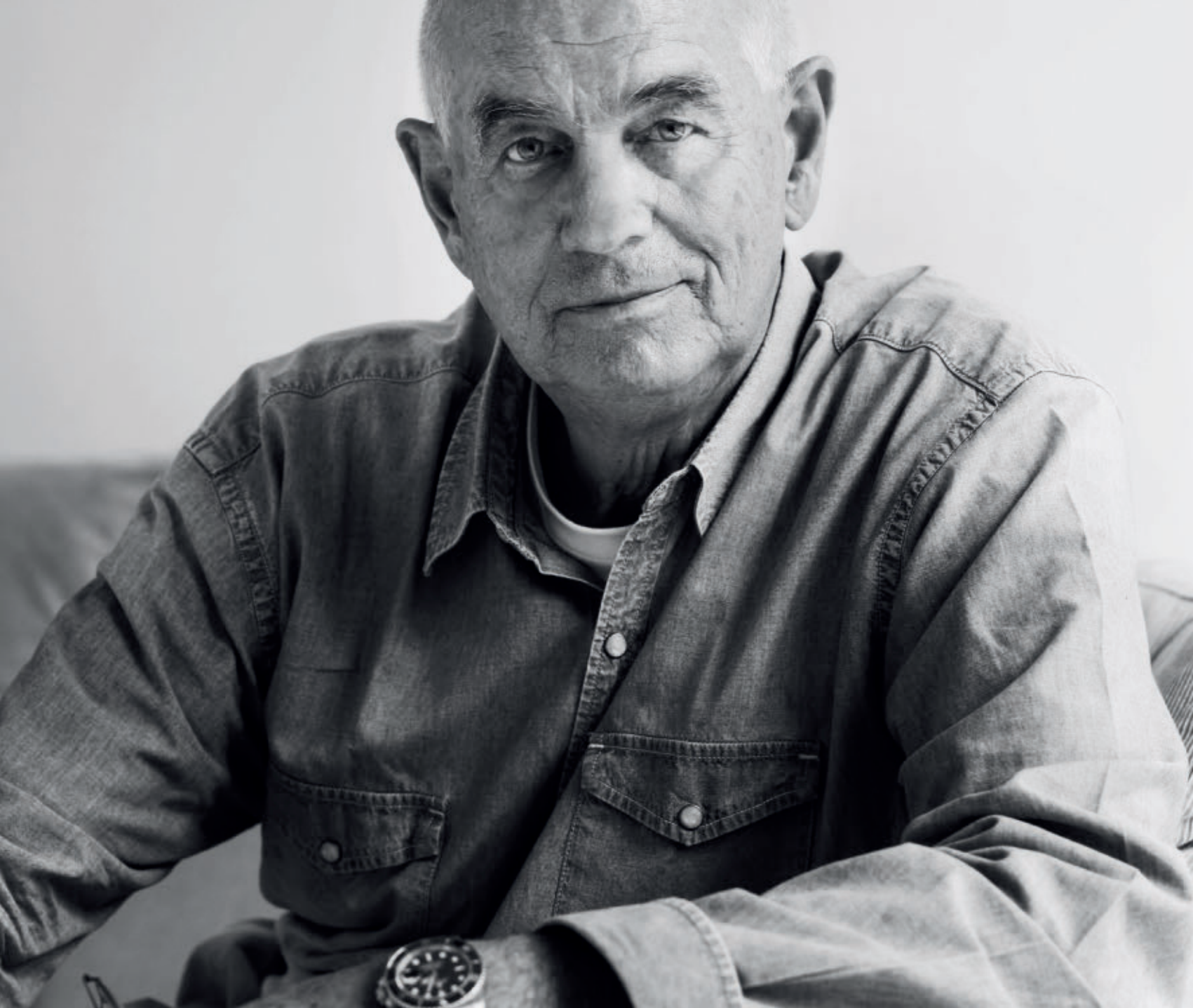

You are what you seat

11

## Every most single design in our range of couches carries his signature.

With the simplistic, yet sophisticated Baseline, Jens Juul Eilersen struck a cord with people who make sense of proportions. Being third generation in a family of craftsmen is not a bad luggage, if you aim to change the common perception of how a couch should look and feel.



Once upon a time, in a kingdom by the sea, there lived a young man, who was unusually good with his hands.

In spite of his modest age, he had known all his life that one day he would show the world what those hands were capable of. Niels Eilersen was his name, and this was his plan: “I’m going to build a coach, but not just any coach. I will build a hunting wagon, and it is going to be the lightest and the strongest and the most manoeuvrable in the county.”





Young Niels built his hunting wagon, and people travelled from outside the county to admire it. And though he did not own a horse to put in front of it, his coach became the start of a business that would grow into a dynasty. The year was 1895, and four generations of Eilersen have since toiled to keep up with Niels' aspirations. Focus may have changed from coaches to couches, but ambition still strives.

When you put your heart into it, you might just build the best sofa in the world.





Page 122 Sofa Ajour



Page 124 Sofa Box



Page 98 Chair Control/Control Glove



Page 110 Sofa Flap



Page 106 Sofa Ash



Page 84 Sofa Butterfly



Page 102 Sofa Dacapo



Page 28 Sofa Float



Page 58 Sofa Baseline



Page 80 Sofa Chess



Page 34 Sofa Drop



Page 32 Sofa Float High



Page 92 Sofa Bermuda



Page 62 Sofa Cocoon



Page 90 Sofa Fatty



Page 72 Sofa Gotham



Page 42 Sofa Great Ash



Page 100 Sofa Lift



Page 66 Sofa Great Lift



Page 94 Sofa Mission



Page 112 Sofa Great Pampas



Page 118 Sofa Odense



Page 68 Sofa High Box



Page 76 Sofa Plano



Page 88 Sofa Playground



Page 114 Sofa Skagen



Page 120 Sofa Rig



Page 126 Sofa Slice



Page 74 Sofa Savanna



Page 24 Sofa Slimline



Page 38 Sofa Session



Page 46 Sofa Slope





Page 54 Sofa Streamline



Page 50 Sofa Tub



Page 128 Sofa Zenith



Page 66 Footstool Bag



Page 88 Footstool Bun



Page 118 Footstool Square



Page 134 Footstool Wheel



Page 34 Chair Ashton



Page 32 Chair Safari



Page 58 Chair Stable



Page 92 Table Circus



Page 46 Table Frame



Page 38 Table Kant



Page 42 Table Island



Page 130 Table Puzzle



Page 28 Table Spider Square



Page 24 Table Spider Triangel



Page 34 Carpet Field

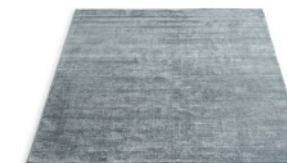

Page 132 Carpet Stick



Right: Sofa Slimline  
220 x 92 cm / 86 1/2" x 36 1/4"  
Leather Ranch 18

Carpet: Border  
Table: Spider Triangel

Below: Sofa Slimline  
240 x 92 cm / 94 1/2" x 36 1/4"  
Fabric Gravel 20

Design by Jens Juul Eilersen  
*More details page 164*





Left: Sofa Slimline  
Leather Ranch 18

Table: Spider Triangel

Below: Sofa Slimline  
220 x 92 cm / 86 1/2" x 36 1/4"  
Leather Ranch 18

Design by Jens Juul Eilersen  
*More details page 164*





Right: Sofa Float  
260 x 100 cm / 102 1/4" x 39 1/4"  
Fabric Gravel 07

Carpet: Stick  
Table: Spider Square  
Footstool: Wheel

Below: Sofa Float  
260 x 100 cm / 102 1/4" x 39 1/4"  
Fabric Gravel 07

Design by Jens Juul Eilersen  
*More details page 150*





Left: Sofa Float  
Fabric Gravel 07

Below: Sofa Float  
Fabric Gravel 07

Design by Jens Juul Eilersen  
*More details page 150*





Right: Sofa Float High  
330 x 100 cm / 130" x 39 1/4"  
Fabric Herring 20

Chair: Safari  
Table: Spider Square  
Carpet: Stick

Below: Sofa Float High  
330 x 100 cm / 130" x 39 1/4"  
Fabric Herring 20

Design by Jens Juul Eilersen  
*More details page 150*





Right: Sofa Drop  
240 x 350 cm / 94 1/2" x 137 3/4"  
Fabric André 26

Chair: Ashton  
Table: Puzzle  
Carpet: Field  
Table: Spider Triangel

Below: Sofa Drop  
280 x 100 cm / 110 1/4" x 39 1/4"  
Fabric Gravel 07

Design by Jens Juul Eilersen  
*More details page 148*

With wide seats built into the body, Drop blends tight and soft lines to form a contemporary, cultivated experience. Soft cushions emphasize a classic appearance.





Sofa Drop  
280 x 100 cm / 110 1/4" x 39 1/4"  
Fabric Gravel 07

Design by Jens Juul Eilersen  
*More details page 148*





Right: Sofa Session  
220 x 92 cm / 86 1/2" x 36 1/4"  
Fabric Desert o6

Table: Spider Square  
Carpet: Field  
Table: Kant

Below: Sofa Session  
220 x 92 cm / 86 1/2" x 36 1/4"  
Fabric Desert o6

Design by Nishiyama-Eilersen team  
*More details page 162*







Left: Sofa Session  
Fabric Desert 06

Below: Sofa Session  
220 x 92 cm / 86 1/2" x 36 1/4"  
Fabric Desert 06

Design by Nishiyama-Eilersen team  
*More details page 162*





Right: Sofa Great Ash  
360 x 100 cm / 141 3/4" x 39 3/4"  
Fabric Bubble II 108

Carpet: Stick  
Table: Island

Below: Sofa Great Ash  
360 x 100 cm / 141 3/4" x 39 3/4"  
COM fabric

Design by Jens Juul Eilersen  
*More details page 152*

Wide seats, just the right pitch, and plenty of down-fill to keep you comfy, Great Ash is Eilersen to the bone. It makes you want to kick off your shoes.







Left: Sofa Great Ash  
Fabric Bubble II 108

Table: Island

Below: Sofa Great Ash  
Fabric Bubble II 108

Design by Jens Juul Eilersen  
*More details page 152*





Right: Sofa Slope  
280 x 100 cm / 110 1/4" x 39 1/4"  
Fabric Gravel 26

Carpet: Field

Below: Sofa Slope  
260 x 100 cm / 102 1/4" x 39 1/4"  
Fabric Nature 03

Design by Jens Juul Eilersen  
*More details page 165*





Below: Sofa Slope  
340 x 240 cm / 133 3/4" x 94 1/2"  
Fabric Gravel 26

Design by Jens Juul Eilersen  
*More details page 165*





Right: Sofa Tub  
240 x 94 cm / 94 1/2" x 37"  
Fabric Nature 17

Carpet: Stick  
Table: Frame

Below: Sofa Tub  
300 x 104 cm / 118" x 41"  
COM fabric

Design by Jens Juul Eilersen  
*More details page 168*

A feast of foam, down and pillows, Tub present  
you with a choice of two depths of seat.  
Define your own comfort zone.





Sofa Tub  
260 x 94 cm / 102 1/4" x 37"  
Leather Mimosa 18

Design by Jens Juul Eilersen  
*More details page 168*





Right: Sofa Streamline  
240 x 151/91 cm / 86 1/2" x 59 1/2" / 35 3/4"  
Fabric Nature 17

Chair: Safari  
Carpet: Stick  
Table: Spider Triangel

Below: Sofa Streamline  
220 x 91 cm / 86 1/2" x 35 3/4"  
Fabric Soft 09

Design by Jens Juul Eilersen  
*More details page 166*

Streamline is the classic, clean sofa. Or an invitation to build your own personalized space from a wide range of sections and chaiselongues. Add your best pillows and hop in.







Left: Sofa Streamline  
Fabric Nature 17

Below: Sofa Streamline  
220 x 91 cm / 86 1/2" x 35 3/4"  
Fabric Mellow 34

Design by Jens Juul Eilersen  
*More details page 166*





Right: Sofa Baseline  
350 x 100 cm / 137 3/4" x 39 1/4"  
Fabric Pierre 07

Chair: Stable  
Carpet: Lama

Below: Sofa Baseline  
325 x 160/100 cm / 128" x 63"/39 1/4"  
COM fabric

Design by Jens Juul Eilersen  
*More details page 143*

Born a classic and named after its expression, Baseline is the obvious starting point for reshaping your home. With armrests as wide as these, who needs a table?





Sofa Baseline  
350 x 100 cm / 137 3/4" x 39 1/4"  
Fabric Mumbai 06

Design by Jens Juul Eilersen  
*More details page 143*





Right: Sofa Cocoon with low and high arm and back  
350 x 106 cm / 137 3/4" x 41 3/4"  
Fabric Herring 17

Table: Spider Square  
Carpet: Stick

Below: Sofa Cocoon with high arm and back  
360 x 106 cm / 141 3/4" x 41 3/4"  
COM fabric

Design by Jens Juul Eilersen  
*More details page 146*

Choose cushions and sections in different fabrics or plain colours and snug up in your very own Cocoon.  
Some want to sit, others to float.





Sofa Cocoon with high arm and back  
320 x 106 cm / 149 1/2" x 41 3/4"  
Fabric Bubble II multi color

Design by Jens Juul Eilersen  
*More details page 146*





Right: Sofa Great Lift  
240 x 107 cm / 94 1/2" x 42 1/4"  
Fabric Louis 16

Footstool: Bag

Below: Sofa Great Lift  
240 x 107 cm / 94 1/2" x 42 1/4"  
COM fabric

Design by Jens Juul Eilersen  
*More details page 152*

Great Lift has a sectioned lifting mechanism,  
which allows the backrest to be set individually  
Roll-pillows for arms, legs and under knees.





Right: Sofa High Box  
220 x 97 cm / 86 1/2" x 38 1/4"  
Fabric Cross 26

Table: Spider Square  
Carpet: Stick

Below: Sofa High Box  
220 x 97 cm / 86 1/2" x 38 1/4"  
COM fabric

Design by Jens Juul Eilersen  
*More details page 153*





Sofa High Box  
220 x 97 cm / 86 1/2" x 38 1/4"  
Fabric Soft 31

Design by Jens Juul Eilersen  
*More details page 153*





Right: Sofa Gotham  
340 x 100 cm / 133 3/4" x 39 1/4"  
Leather Mimosa 18

Chair: Safari  
Carpet: Stick  
Table: Puzzle  
Carpet: Lama  
Footstool: Bun

Below: Sofa Gotham  
280 x 100 cm / 110 1/4" x 39 1/4"  
Leather Mimosa 01

Design by Jens Juul Eilersen  
*More details page 151*





Right: Sofa Savanna  
308 x 268 cm / 121 1/4" x 105 1/2"  
Fabric Tangent 16

Footstool: Bun  
Table: Spider Square

Below: Sofa Savanna  
320 x 100 cm / 126" x 39 1/4"  
Fabric Soft 26

Design by Jens Juul Eilersen  
*More details page 160*

Savanna sections grow in steps of 10 cm, from 100 cm to 240 cm, for precision and absolute flexibility. Strong, classic lines on slender legs.





Right: Sofa Plano  
340 x 240 cm / 133 3/4" x 94 1/2"  
Fabric Desert 07

Table: Puzzle  
Carpet: Stick  
Footstool: Wheel

Below: Sofa Plano  
300 x 240 cm / 118" x 94 1/2"  
Fabric Pierre 14

Design by Jens Juul Eilersen  
*More details page 156*

With back cushions in various sizes, Plano adds a breezy cosiness to any room regardless of size. Lounge the Scandinavian way, even in urban spaces.







Left: Sofa Plano  
Fabric Misty 20

Below: Sofa Plano  
280 x 240 cm / 110 1/4" x 94 1/2"  
Fabric Nueva 130

Design by Jens Juul Eilersen  
*More details page 156*





Right: Sofa Chess  
270 x 115 cm / 106 1/4" x 45 1/4"  
Fabric Nature 17

Carpet: Border

Below: Sofa Chess  
330 x 155/95 cm / 130" x 61"/37 1/2"  
Fabric Tangent 09

Design by Jens Juul Eilersen  
*More details page 145*

A sofa and a module system, Chess can be put together in different depths for a versatile and creative expression. Stretch your sofa into an entire landscape.





Sofa Chess  
250 x 95 cm / 98 1/2" x 37 1/2"  
Fabric Nature 08

Design by Jens Juul Eilersen  
*More details page 145*





Right: Sofa Butterfly  
220 x 90 cm / 86 1/2" x 35 1/5"  
Fabric Bubble II 128

Below: Sofa Butterfly  
220 x 90 cm / 86 1/2" x 35 1/5"  
Fabric Yarn 23

Design by Nishiyama-Eilersen team  
*More details page 144*

Create groups of two and three seaters anywhere in your room. Butterfly even comes as an armchair. Slim from the back, generous from the front.





Sofa Butterfly  
220 x 90 cm / 86 1/2" x 35 1/5"  
Fabric Yarn 23

Design by Nishiyama-Eilersen team  
*More details page 144*





Right: Sofa Playground  
210 x 115 cm / 82 3/4" x 45 1/4"  
Fabric Yarn 07 and Gravel 20

Carpet: Stick  
Footstool: Bun  
Table: Spider Square  
Table: Spider Triangel  
Carpet: Stick

Below: Sofa Playground  
210 x 115 cm / 82 3/4" x 45 1/4"  
Fabric Termoli 120

Design by Jens Juul Eilersen  
*More details page 157*





Right: Sofa Fatty  
380 x 105 cm / 149 1/2" x 41 1/4"  
Fabric Herring 29

Carpet: Stick  
Table: Spider Square  
Footstool: Bun  
Carpet: Stick  
Table: Spider Triangel

Below: Sofa Fatty  
320 x 105 cm / 126" x 41 1/4"  
Fabric Soft 23

Design by Jens Juul Eilersen  
*More details page 148*

Calm low lines, a deep seat, and armrests wide as tea trays make Fatty destined for open spaces. Lounge in the middle of your room.





Right: Sofa Bermuda  
334 x 264 cm / 131 1/2" x 104"  
Fabric Tangent 07

Carpet: Field  
Table: Circus

Below: Sofa Bermuda  
320 x 104 cm / 126" x 41"  
Fabric Pierre 03

Design by Jens Juul Eilersen  
*More details page 143*

A reinterpretation of the classic sofa, Bermuda merges back and arms into one, sloping slightly on the inside for increased comfort. Back and arms in one.





Right: Sofa Mission  
240 x 90 cm / 94 1/2" x 35 1/2"  
Leather Pure 18

Carpet: Lama  
Table: Circus  
Chair: Ashton  
Table: Kant

Below: Sofa Mission  
220 x 90 cm / 86 1/2" x 35 1/2"  
Fabric Nature 39

Design by Nishiyama-Eilersen team  
*More details page 154*







Left: Sofa Mission  
Fabric Tangent 07

Below: Sofa Mission  
218 x 258 cm / 85 3/4" x 101 1/2"  
Fabric Soft 22

Design by Nishiyama-Eilersen team  
*More details page 154*





Right: Chair Control  
85 x 182 cm / 33 1/2" x 71 3/4"  
Fabric Pierre 18

Below: Chair Control Glove  
85 x 182 cm / 33 1/2" x 71 3/4"  
Leather Bull 01

Design by Jens Juul Eilersen  
*More details page 146*





Right: Sofa Lift  
240 x 90 cm / 94 1/2" x 35 1/2"  
Leather Mimosa 18

Table: Spider Square

Below: Sofa Lift  
240 x 90 cm / 94 1/2" x 35 1/2"  
Fabric Louis 14

Design by Jens Juul Eilersen  
*More details page 154*

Lift lets you raise the backrest an extra 13 cm for added neck support. Choose between two options: foam/fibre or down-padded.  
Raise the backrest for added neck support.





Right: Sofa Dacapo  
335 x 310 cm / 132" x 122"  
Fabric Bubble II 107

Table: Spider Square

Below: Sofa Dacapo  
345 x 105 cm / 135 3/4" x 39 1/4"  
Fabric Nami 20

Design by Jens Juul Eilersen  
*More details page 147*

Dacapo boasts a wide range of corners, centres, and chaise-longues plus various types of armrest cushions and stools. Design your own landscape lounge.





Sofa Dacapo  
340 x 165/105 cm / 133 3/4" x 65"/41 1/4"  
Fabric Benga 07

Design by Jens Juul Eilersen  
*More details page 147*





Right: Sofa Ash  
240 x 98 cm / 94 1/2" x 38 1/2"  
Fabric Nature 39

Table: Spider Triangel  
Carpet: Stick

Below: Sofa Ash  
240 x 98 cm / 94 1/2" x 38 1/2"  
Leather Texas Plus 262

Design by Jens Juul Eilersen  
*More details page 142*







Left: Sofa Ash  
Fabric Nature 39

Below: Sofa Ash  
240 x 98 cm / 94 1/2" x 38 1/2"  
Leather Texas Plus 262

Design by Jens Juul Eilersen  
*More details page 142*





Right: Sofa Flap  
280 x 100 cm / 110 1/4" x 39 1/4"  
Fabric Cross 36

Table: Spider Triangel

Below: Sofa Flap  
380 x 100 cm / 149 1/2" x 39 1/4"  
Fabric Fun Square 18

Design by Jens Juul Eilersen  
*More details page 149*





Right: Sofa Great Pampas  
420 x 120 cm / 165 1/4" x 47 1/4"  
Multi fabric from right:  
Bakar 27, Mellow 26, COM fabric and COM fabric

Below: Sofa Great Pampas  
420 x 120 cm / 165 1/4" x 47 1/4"  
Multi fabric COM fabric.

Design by Jens Juul Eilersen  
*More details page 153*





Right: Sofa Skagen  
220 x 85 cm / 86 1/2" x 33 1/2"  
Fabric Cotton 16

Table: Spider Square  
Carpet: Field  
Footstool: Wheel

Below: Sofa Skagen  
220 x 85 cm / 86 1/2" x 33 1/2"  
Fabric Bubble II 128

Design by Jens Juul Eilersen  
*More details page 163*







Left: Sofa Skagen  
Fabric Cotton 16

Below: Sofa Skagen  
220 x 85 cm / 86 1/2" x 33 1/2"  
Fabric Bubble II 128

Design by Jens Juul Eilersen  
*More details page 163*





Right: Sofa Odense  
240 x 144/84 cm / 94 1/2" x 56 3/4"/33"  
COM leather

Footstool: Square  
Table: Spider Triangel  
Carpet: Stick

Below: Sofa Odense  
230 x 84 cm / 90 1/2" x 33"  
Fabric Termoli 137

Design by Jens Juul Eilersen  
*More details page 155*





Right: Sofa Rig  
400 x 170/100 cm / 157 1/2" x 67"/39 1/4"  
Multi fabric: From right Pierre 18, Mellow 34 and COM fabric

Below: Sofa Rig  
320 x 320 cm / 126" x 126"  
Fabric Mellow 34

Design by Jens Juul Eilersen  
*More details page 158*





Right: Sofa Ajour  
240 x 100 cm / 94 1/2" x 39 1/4"  
Fabric Nature 07

Carpet: Lama

Below: Sofa Ajour  
240 x 100 cm / 94 1/2" x 39 1/4"  
Fabric Nature 07

Design by Jens Juul Eilersen  
*More details page 142*





Right: Sofa Box  
220 x 111 cm / 86 1/2" x 43 3/4"  
Fabric Pierre 08

Table: Spider Square  
Footstool: Wheel

Below: Sofa Box  
220 x 97 cm / 86 1/2" x 38 1/4"  
Fabric Napoleon 26

Design by Jens Juul Eilersen  
*More details page 144*





Right: Sofa Slice  
230 x 86 cm / 90 1/2" x 33 3/4"  
Fabric Bubble II 106

Table: Spider Triangel

Below: Sofa Slice  
220 x 86 cm / 86 1/2" x 33 3/4"  
Leather Toledo 10

Design by Jens Juul Eilersen  
*More details page 164*





Right: Sofa Zenith  
240 x 100 cm / 94 1/2" x 39 1/4"  
Fabric Misty 16

Below: Sofa Zenith  
240 x 100 cm / 94 1/2" x 39 1/4"  
Fabric Soft 26

Design by Jens Juul Eilersen  
*More details page 169*





Right: Table Puzzle, PU lack, added brown color  
Ø125 cm, height 30 cm / Ø49 1/4", height 11 3/4"  
Glass table top, tinted brown

Below: Table Puzzle, PU lack, added brown color  
120 x 120 cm, height 30 cm / 47 1/4" x 47 1/4", height 11 3/4"  
Glass table top, transparent

Design by Jens Juul Eilersen  
*More details page 173*





Right: Carpet Stick  
170 x 240 cm / 67" x 94 1/2"  
Color Aqua

Table: Spider with Onyx table top

Below: Carpet Stick  
170 x 240 cm / 67" x 94 1/2"  
Color Silver

Design by Jens Juul Eilersen  
*More details page 174*

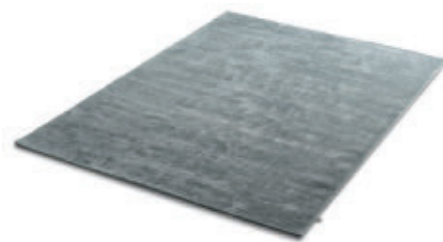



Right: Footstool Wheel  
Ø100 cm / Ø39 1/4"  
Fabric Napoleon 23

Carpet: Stick

Below: Footstool Wheel  
Ø80 cm / Ø31 1/2"  
Fabric Soft 29

Design by Jens Juul Eilersen  
*More details page 174*







When you finally manage to escape

Originals only



When surrounded by natural elegance

Originals only





When you receive an unexpected answer



Originals only



When you are ready for your next move



Originals only





When grace can't be tamed



Originals only



When you develop a taste for more



Originals only





## Model Ajour

Arm height: 60 cm / 23 1/2"

Arm width: 3,2 cm / 1 1/4"

Total depth (frame): 100 cm / 39 1/4"

Seat depth: 54 cm / 21 1/4"

Seat height: 38 cm / 15"

Total height (frame): 60 cm / 23 1/2"

All overall dimensions correspond to frame sizes.

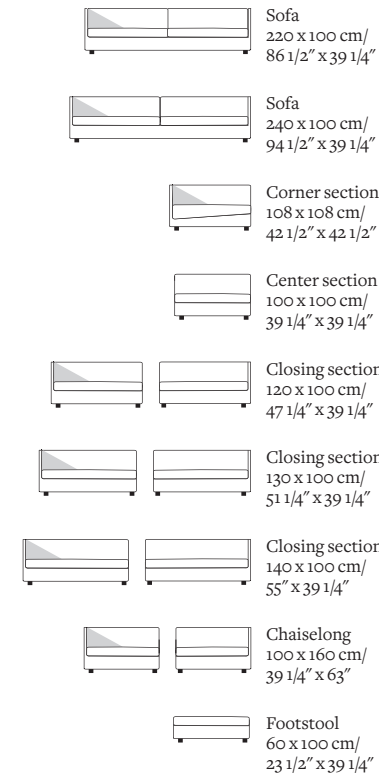

## Model Ash

Arm height: 61,5 cm / 24 1/4"

Arm width: 5 cm / 2"

Total depth (frame): 98 cm / 38 1/2"

Seat depth: 52 cm / 20 1/2"

Seat height: 41 cm / 16 1/4"

Total height (frame): 68,5 cm / 27"

All overall dimensions correspond to frame sizes.

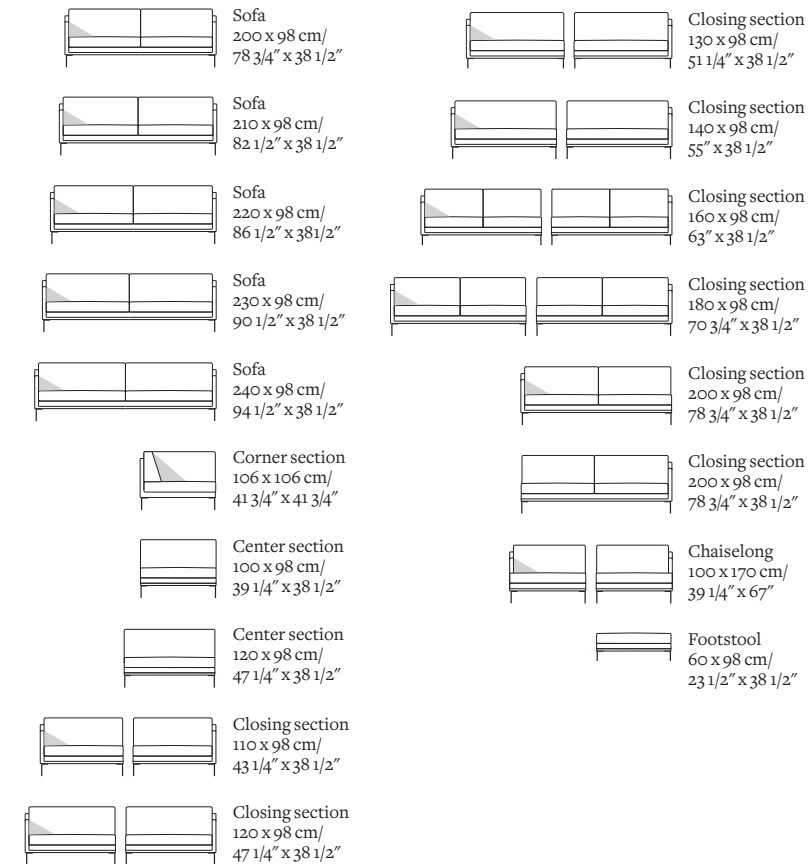

## Model Baseline

Arm height: 61 cm / 24"

Arm width: 2,4 cm / 9 1/2"

Total depth (frame): 100 cm / 39 1/4"

Seat depth: 52 cm / 20 1/2"

Seat height: 40 cm / 15 3/4"

Total height (frame): 61 cm / 24"

All overall dimensions correspond to frame sizes.

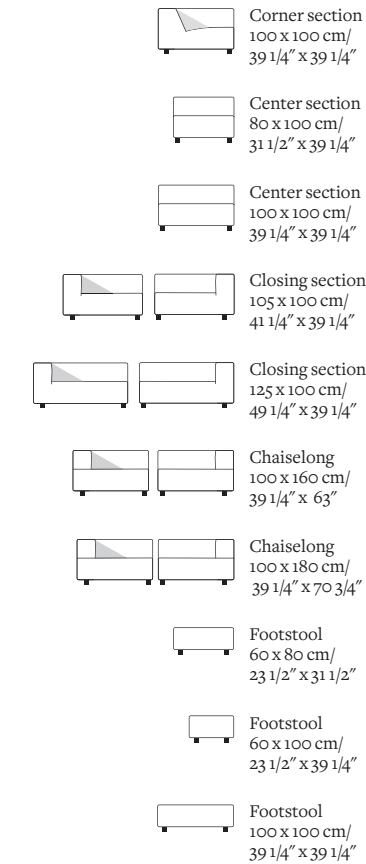

## Model Bermuda

Arm height: 63 cm / 24 3/4"

Arm width: 25 cm / 9 3/4"

Total depth (frame): 104 cm / 41"

Seat depth: 55 cm / 21 3/4"

Seat height: 42 cm / 16 1/2"

Total height (frame): 63 cm / 24 3/4"

All overall dimensions correspond to frame sizes.

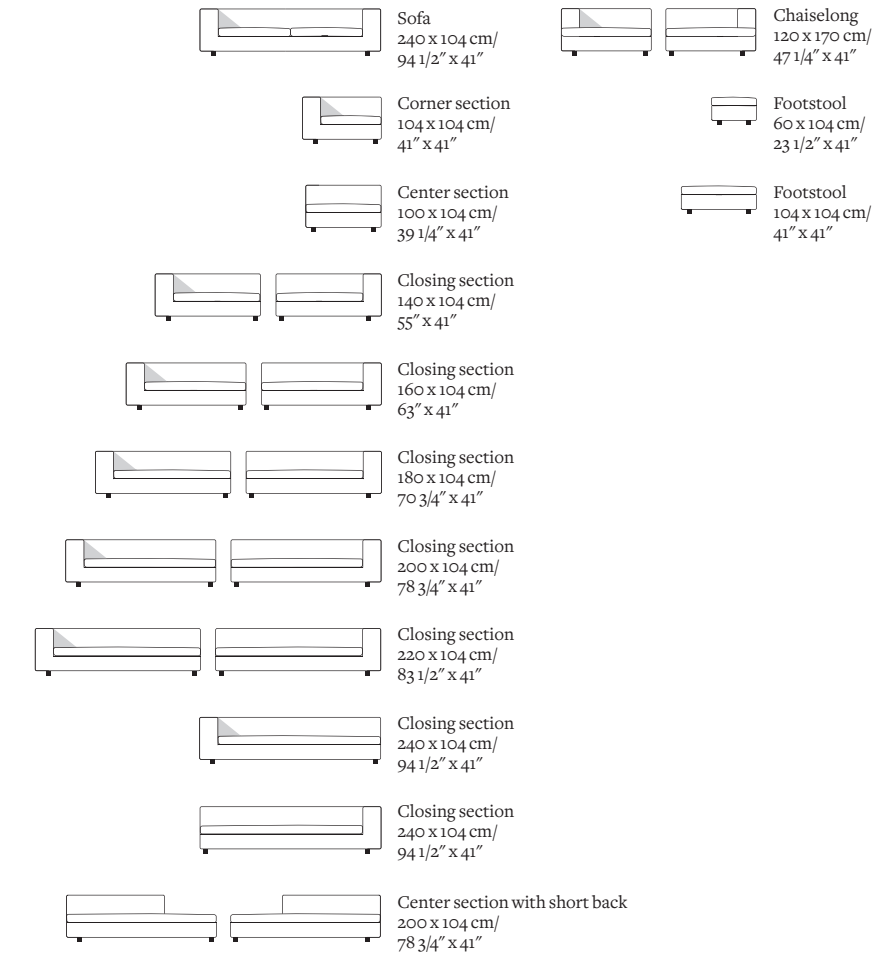



## Model Box

Arm height: 66 cm / 26"

Arm width: 6 cm / 2 1/4"

Total depth (frame): 97 and 111 cm / 38 1/4" and 43 3/4"

Seat depth: 58 and 53 cm / 22 3/4" and 20 3/4"

Seat height: 42 cm / 16 1/2"

Total height (frame): 67 cm / 26 1/2"

All overall dimensions correspond to frame sizes.



Chair  
70 x 97 cm/  
27 1/2" x 38 1/4"

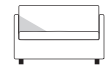

Love Chair  
119 x 97 cm/  
46 3/4" x 38 1/4"

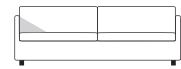

Sofa  
220 x 97 cm/  
86 1/2" x 38 1/4"



Sofa  
220 x 97 cm/  
86 1/2" x 38 1/4"

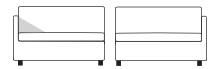

Closing section  
120 x 111 cm/  
47 1/2" x 43 3/4"

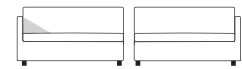

Closing section  
140 x 111 cm/  
55" x 43 3/4"



Footstool  
60 x 100 cm/  
23 1/2" x 39 1/4"

## Model Butterfly

Arm height: 56 cm / 22"

Arm width: 5 cm / 2"

Total depth (frame): 90 cm / 35 1/2"

Seat depth: 51 cm / 20"

Seat height: 40 cm / 15 3/4"

Total height (frame): 71 cm / 28"

All overall dimensions correspond to frame sizes.



Sofa  
200 x 90 cm/  
78 3/4" x 35 1/2"

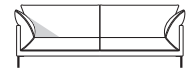

Sofa  
220 x 90 cm/  
86 1/2" x 35 1/2"

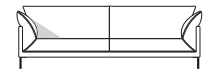

Sofa  
240 x 90 cm/  
94 1/2" x 35 1/2"

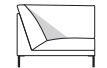

Corner section  
98 x 98 cm/  
38 1/2" x 38 1/2"

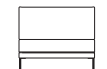

Center section  
100 x 90 cm/  
39 1/4" x 35 1/2"

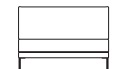

Center section  
120 x 90 cm/  
47 1/4" x 35 1/2"



Closing section  
120 x 90 cm/  
47 1/4" x 35 1/2"



Closing section  
140 x 90 cm/  
55" x 35 1/2"



Closing section  
160 x 90 cm/  
63" x 35 1/2"



Closing section  
180 x 90 cm/  
70 3/4" x 35 1/2"



Closing section  
200 x 90 cm/  
78 3/4" x 35 1/2"

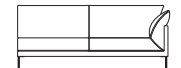

Closing section  
200 x 90 cm/  
78 3/4" x 35 1/2"



Chaiselong  
110 x 160 cm/  
43 1/4" x 63"



Footstool  
60 x 90 cm/  
23 1/2" x 35 1/2"

## Model Chess

Arm height: 61 cm / 24"

Arm width: 15 - 30 cm / 6" - 11 3/4"

Total depth (frame): 95 and 115 cm / 37 1/2" and 45 1/2"

Seat depth: 50/70 cm / 19 3/4"/27 1/2"

Seat height: 41 cm / 16 1/2"

Total height (frame): 61 cm / 24"

All overall dimensions correspond to frame sizes.



Sofa  
210 x 95 cm/  
82 3/4" x 37 1/2"



Sofa  
230 x 95 cm/  
90 1/2" x 37 1/2"



Sofa  
250 x 95 cm/  
98 1/2" x 37 1/2"



Corner section  
95 x 95 cm/  
37 1/2" x 37 1/2"

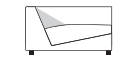

Corner section  
Left 95 x right 115 cm/  
Left 37 1/2" x right 45 1/4"



Corner section  
Left 115 x right 95 cm/  
Left 45 1/4" x right 37 1/2"

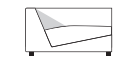

Corner section  
115 x 115 cm/  
45 1/4" x 45 1/4"



Centre section  
100 x 95 cm / 100 x 115 cm  
39 1/4" x 37 1/2" / 39 1/4" x 45 1/4"

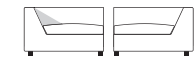

Closing section  
105 x 95 cm/  
41 1/4" x 37 1/2"



Closing section  
115 x 95 cm/  
45 1/4" x 37 1/2"

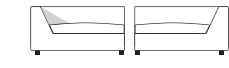

Closing section  
125 x 95 cm/  
49 1/4" x 37 1/2"

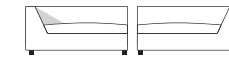

Closing section  
135 x 95/115 cm /  
53 1/4" x 37 1/2" / 45 1/4"

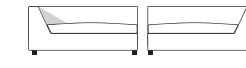

Closing section  
145 x 95 cm/  
57" x 37 1/2"

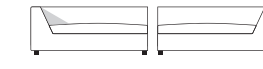

Closing section  
155 x 95 cm/  
61" x 37 1/2"

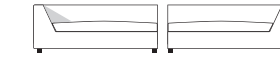

Closing section  
165 x 95 cm/  
65" x 37 1/2"

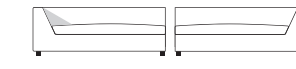

Closing section  
175 x 95 cm/  
69" x 37 1/2"

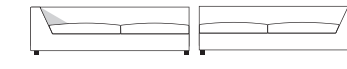

Closing section  
210 x 95 cm/  
82 3/4" x 37 1/2"

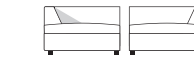

Chaiselong  
100 x 155 cm/  
39 1/4" x 61"

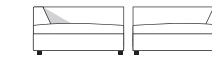

Chaiselong  
120 x 155 cm/  
47 1/4" x 61"



Footstool  
60 x 100 cm/  
23 1/2" x 39 1/4"



Footstool  
60 x 80 cm/  
23 1/2" x 31 1/2"



## Model Cocoon w/high arm and back

Arm height: 73 cm / 28 3/4"  
 Arm width: 7 cm / 2 3/4"  
 Total depth (frame): 106 cm / 41 3/4"  
 Seat depth: 58 cm / 22 3/4"  
 Seat height: 36 cm / 14 1/4"  
 Total height (frame): 73 cm / 28 3/4"  
 All overall dimensions correspond to frame sizes.



Easy Chair  
 114 x 106 cm/  
 45" x 41 3/4"



Corner section  
 106 x 106 cm/  
 41 3/4" x 41 3/4"



Centre section  
 100 x 106 cm/  
 39 1/4" x 41 3/4"



Closing section  
 110 x 106 cm/  
 43 1/4" x 41 3/4"



Closing section  
 120 x 106 cm/  
 47 1/4" x 41 3/4"



Closing section  
 130 x 106 cm/  
 51 1/4" x 41 3/4"



Closing section  
 140 x 106 cm/  
 55" x 41 3/4"



Chaiselong  
 120 x 166 cm/  
 47 1/4" x 65 1/4"



Footstool  
 60 x 100 cm/  
 23 1/2" x 39 1/4"



Footstool  
 60 x 120 cm/  
 23 1/2" x 47 1/4"

## Model Cocoon w/low arm and back

Arm height: 63 cm / 24 3/4"  
 Arm width: 7 cm / 2 3/4"  
 Total depth (frame): 106 cm / 41 3/4"  
 Seat depth: 58 cm / 22 3/4"  
 Seat height: 36 cm / 14 1/4"  
 Total height (frame): 63 cm / 24 3/4"  
 All overall dimensions correspond to frame sizes.



Easy Chair  
 114 x 106 cm/  
 45" x 41 3/4"



Corner section  
 106 x 106 cm/  
 41 3/4" x 41 3/4"



Centre section  
 100 x 106 cm/  
 39 1/4" x 41 3/4"



Closing section  
 110 x 106 cm/  
 43 1/4" x 41 3/4"



Closing section  
 120 x 106 cm/  
 47 1/4" x 41 3/4"



Closing section  
 130 x 106 cm/  
 51 1/4" x 41 3/4"



Closing section  
 140 x 106 cm/  
 55" x 41 3/4"



Chaiselong  
 120 x 166 cm/  
 47 1/4" x 65 1/4"



Footstool  
 60 x 100 cm/  
 23 1/2" x 39 1/4"



Footstool  
 60 x 120 cm/  
 23 1/2" x 47 1/4"

## Model Control

Back height (3 steps): 44 - 105 cm / 17 1/4" - 41 1/4"  
 Foot Support (2 steps): 23 - 42 cm / 9" - 16 1/2"  
 Seat height: 39 cm / 15 1/4"  
 All overall dimensions correspond to frame sizes.



Easy chair  
 85 x 182 cm/  
 33 1/2" x 71 3/4"



Easy chair  
 70 x 182 cm/  
 27 1/2" x 71 3/4"

## Model Control Glove

Back height (3 steps): 44 - 105 cm / 17 1/4" - 41 1/4"  
 Foot Support (2 steps): 23 - 42 cm / 9" - 16 1/2"  
 Seat height: 39 cm / 15 1/4"  
 All overall dimensions correspond to frame sizes.



Easy chair  
 85 x 182 cm/  
 33 1/2" x 71 3/4"

## Model Dacapo

Arm height: 46 cm / 18"  
 Arm width: 20 - 30 - 40 cm / 7 1/2" - 11 3/4" - 15 3/4"  
 Total depth (frame): 105 cm / 41 1/4"  
 Seat depth: 50 cm / 19 3/4"  
 Seat height: 39 cm / 15 1/4"  
 Total height (frame): 66 cm / 26"  
 All overall dimensions correspond to frame sizes.



Closing section  
 120 x 105 cm/  
 47 1/4" x 41 1/4"



Closing section  
 170 x 105 cm/  
 67" x 41 1/4"



Chaiselong  
 120 x 165 cm/  
 47 1/4" x 65"



Closing section  
 130 x 105 cm/  
 51 1/4" x 41 1/4"



Closing section  
 180 x 105 cm/  
 70 3/4" x 41 1/4"



Chaiselong  
 130 x 165 cm/  
 51 1/4" x 65"



Closing section  
 140 x 105 cm/  
 55" x 41 1/4"



Closing section  
 190 x 105 cm/  
 74 3/4" x 41 1/4"



Chaiselong  
 140 x 165 cm/  
 55" x 65"



Closing section  
 w.o. arm  
 100 x 105 cm/  
 39 1/4" x 41 1/4"



Closing section  
 w.o. arm  
 150 x 105 cm/59" x 41 1/4"



Chaiselong  
 w.o. arm  
 100 x 165 cm/39 1/4" x 65"

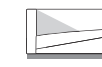

Corner section  
 105 x 105 cm/  
 41 1/4" x 41 1/4"

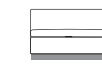

Centre section  
 100 x 105 cm/  
 39 1/4" x 41 1/4"

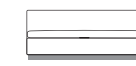

Centre section  
 150 x 105 cm/  
 59" x 41 1/4"



Footstool  
 70 x 105 cm/  
 27 1/2" x 41 1/4"



Footstool  
 105 x 105 cm/  
 41 1/4" x 41 1/4"



Footstool  
 150 x 105 cm/  
 59" x 41 1/4"



Footstool as corner  
 105 x 105 cm/  
 41 1/4" x 41 1/4"



Footstool as closing  
 70 x 105 cm/  
 27 1/2" x 41 1/4"

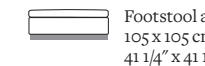

Footstool as closing  
 105 x 105 cm/  
 41 1/4" x 41 1/4"

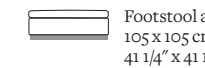

Footstool as closing  
 105 x 105 cm/  
 41 1/4" x 41 1/4"



Footstool as closing  
 150 x 105 cm/  
 59" x 41 1/4"



Footstool as closing  
 150 x 105 cm/  
 59" x 41 1/4"



## Model Drop

Arm height: 60 cm / 23 1/2"

Arm width: 6 cm / 2 1/4"

Total depth (frame): 100 cm / 39 1/4"

Seat depth: 50/68 cm / 19 3/4" / 26 3/4"

Seat height: 40 cm / 15 3/4"

Total height (frame): 60 cm / 23 1/2"

All overall dimensions correspond to frame sizes.

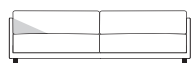

Sofa  
240 x 100 cm/  
94 1/2" x 39 1/4"



Corner section  
100 x 100 cm/  
39 1/4" x 39 1/4"



Center section  
100 x 100 cm/  
39 1/4" x 39 1/4"



Center section  
110 x 100 cm/  
43 1/4" x 39 1/4"



Center section  
120 x 100 cm/  
47 1/4" x 39 1/4"

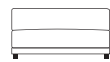

Center section  
130 x 100 cm/  
51 1/4" x 39 1/4"



Center section w. short back  
160 x 100 cm/  
63" x 39 1/4"



Center section w. short back  
180 x 100 cm/  
70 3/4" cm x 39 1/4"



Center section w. short back  
200 x 100 cm/  
78 3/4" cm x 39 1/4"



Closing section  
110 x 100 cm/  
43 1/4" x 39 1/4"



Closing section  
120 x 100 cm/  
47 1/4" x 39 1/4"



Closing section  
130 x 100 cm/  
51 1/4" x 39 1/4"



Closing section  
140 x 100 cm/  
55" x 39 1/4"

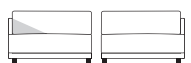

Chaiselong  
110 x 170 cm/  
43 1/4" x 67"



Footstool  
60 x 100 cm/  
23 1/2" x 39 1/4"



Footstool  
70 x 100 cm/  
27 1/2" x 39 1/4"



Footstool  
80 x 100 cm/  
31 1/2" x 39 1/4"

## Model Fatty

Arm height: 55 cm / 21 3/4"

Arm width: 31 cm / 12 1/4"

Total depth (frame): 105 cm / 41 1/4"

Seat depth: 53 cm / 20 3/4"

Seat height: 37 cm / 14 1/2"

Total height (frame): 55 cm / 21 3/4"

All overall dimensions correspond to frame sizes.



Corner section  
105 x 105 cm/  
41 1/4" x 41 1/4"



Center section  
100 x 105 cm/  
39 1/4" x 41 1/4"

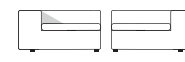

Closing section  
110 x 105 cm/  
43 1/4" x 41 1/4"



Closing section  
130 x 105 cm/  
51 1/4" x 41 1/4"



Closing section  
160 x 105 cm/  
63" x 41 1/4"

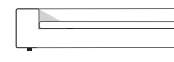

Closing section  
220 x 105 cm/  
86 1/2" x 41 1/4"

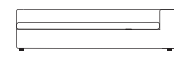

Closing section  
220 x 105 cm/  
86 1/2" x 41 1/4"

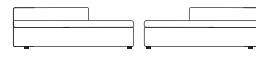

Center w/short back  
160 x 105 cm/  
63" x 41 1/4"



Chaiselong  
120 x 170 cm/  
47 1/4" x 67"



Footstool  
60 x 100 cm/  
23 1/2" x 39 1/4"



Footstool  
110 x 105 cm/  
43 1/4" x 41 1/4"

## Model Flap depth 85 cm

Arm height: 60 cm / 23 1/2"

Arm width: 3,2 cm / 1 1/4"

Total depth (frame): 85 cm / 33 1/2"

Seat depth: 39 cm / 15 1/4"

Seat height: 38 cm / 15"

Total height (frame): 60 cm / 23 1/2"

All overall dimensions correspond to frame sizes.



Sofa  
180 x 85 cm/  
70 3/4" x 33 1/2"



Sofa  
200 x 85 cm/  
78 3/4" x 33 1/2"



Sofa  
220 x 85 cm/  
86 1/2" x 33 1/2"

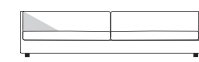

Sofa  
240 x 85 cm/  
94 1/2" x 33 1/2"

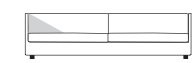

Sofa  
220 x 100 cm/  
86 1/2" x 39 1/4"

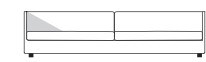

Sofa  
240 x 100 cm/  
94 1/2" x 39 1/4"



Corner section  
108 x 108 cm/  
42 1/2" x 42 1/2"

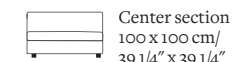

Center section  
100 x 100 cm/  
39 1/4" x 39 1/4"



Closing section  
120 x 100 cm/  
47 1/4" x 39 1/4"



Closing section  
130 x 100 cm/  
51 1/4" x 39 1/4"



Closing section  
140 x 100 cm/  
55" x 39 1/4"

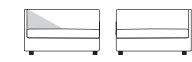

Chaiselong  
100 x 160 cm/  
39 1/4" x 63"

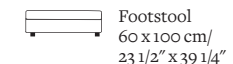

Footstool  
60 x 100 cm/  
23 1/2" x 39 1/4"



## Model Float

Arm height: 58 cm / 22 3/4"

Arm width: 8 cm / 3 1/4"

Arm cushion width: 8 cm / 3 1/4"

Total depth (frame): 100 cm / 39 1/4"

Seat depth: 58/73 cm / 22 3/4" / 28 3/4"

Seat height: 41 cm / 16 1/4"

Total height (frame): 58 cm / 22 3/4"

All overall dimensions correspond to frame sizes.



Sofa  
220 x 100 cm/  
86 1/2" x 39 1/4"



Corner section  
100 x 100 cm/  
39 1/4" x 39 1/4"



Center section  
90 x 100 cm/  
35 1/2" x 39 1/4"



Center section  
100 x 100 cm/  
39 1/4" x 39 1/4"

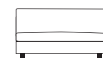

Center section  
120 x 100 cm/  
47 1/4" x 39 1/4"

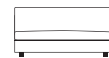

Center section  
140 x 100 cm/  
55" x 39 1/4"

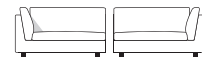

Closing section  
120 x 100 cm/  
47 1/4" x 39 1/4"

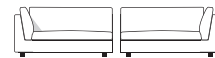

Closing section  
130 x 100 cm/  
51 1/4" x 39 1/4"



Closing section  
140 x 100 cm/  
55" x 39 1/4"



Closing section  
160 x 100 cm/  
63" x 39 1/4"



Footstool  
60 x 100 cm/  
23 1/2" x 39 1/4"



Footstool  
70 x 100 cm/  
27 1/2" x 39 1/4"



Footstool  
100 x 100 cm/  
39 1/4" x 39 1/4"



Footstool as closing  
60 x 100 cm/  
23 1/2" x 39 1/4"



Footstool as closing  
70 x 100 cm/  
27 1/2" x 39 1/4"



Footstool as closing  
100 x 100 cm/  
39 1/4" x 39 1/4"

## Model Float High

Arm height: 59 cm / 23 1/4"

Arm width: 8 cm / 3 1/4"

Arm cushion width: 8 cm / 3 1/4"

Total depth (frame): 100 cm / 39 1/4"

Seat depth: 58/73 cm / 22 3/4" / 28 3/4"

Seat height: 42 cm / 16 1/2"

Total height (frame): 59 cm / 23 1/4"

All overall dimensions correspond to frame sizes.



Sofa  
220 x 100 cm/  
86 1/2" x 39 1/4"



Sofa  
240 x 100 cm/  
94 1/2" x 39 1/4"



Corner section  
100 x 100 cm/  
39 1/4" x 39 1/4"



Center section  
90 x 100 cm/  
35 1/2" x 39 1/4"



Center section  
100 x 100 cm/  
39 1/4" x 39 1/4"



Center section  
120 x 100 cm/  
47 1/4" x 39 1/4"

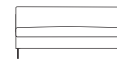

Center section  
140 x 100 cm/  
55" x 39 1/4"



Closing section:  
120 x 100 cm/  
47 1/4" x 39 1/4"



Closing section:  
140 x 100 cm/  
55" x 39 1/4"



Closing section:  
160 x 100 cm/  
63" x 39 1/4"

## Model Gotham

Arm height: 64 cm / 25 1/4"

Arm width: 26 cm / 10 1/4"

Total depth (frame): 100 cm / 39 1/4"

Seat depth: 54 cm / 21 1/4"

Seat height: 42 cm / 16 1/2"

Total height (frame): 64 cm / 25 1/4"

All overall dimensions correspond to frame sizes.



Closing section  
180 x 100 cm/  
70 3/4" x 39 1/4"

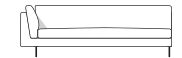

Closing section  
200 x 100 cm/  
78 3/4" x 39 1/4"

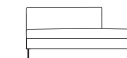

Center section w. short back  
160 x 100 cm/  
63" x 39 1/4"



Center section w. short back  
200 x 100 cm/  
78 3/4" x 39 1/4"



Footstool  
60 x 100 cm/  
23 1/2" x 39 1/4"



Footstool  
100 x 100 cm/  
39 1/4" x 39 1/4"



Footstool as closing  
60 x 100 cm/  
23 1/2" x 39 1/4"



Footstool as closing  
100 x 100 cm/  
39 1/4" x 39 1/4"



Corner section  
100 x 100 cm/  
39 1/4" x 39 1/4"



Center section  
80 x 100 cm/  
31 1/2" x 39 1/4"



Center section  
100 x 100 cm/  
39 1/4" x 39 1/4"



Center section  
160 x 100 cm/  
63" x 39 1/4"

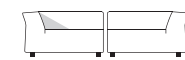

Closing section  
105 x 100 cm/  
41 1/4" x 39 1/4"



Closing section  
125 x 100 cm/  
49 1/4" x 39 1/4"



Closing section  
170 x 100 cm/  
67" x 39 1/4"



Center w. short back  
220 x 100 cm/  
86 1/2" x 39 1/4"

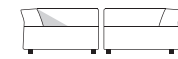

Chaiselong  
100 x 160 cm/  
39 1/4" x 63"

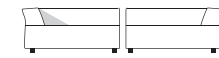

Chaiselong  
130 x 170 cm/  
51 1/4" x 67"



Footstool  
60 x 80 cm/  
23 1/2" x 31 1/2"



## Model Great Ash

Arm height: 56 cm / 22"

Arm width: 5 cm / 2 1/2"

Total depth (frame): 100 cm / 39 1/4"

Seat depth: 52 cm / 20 1/2"

Seat height: 39 cm / 15 1/4"

Total height (frame): 56 cm / 22"

All overall dimensions correspond to frame sizes.

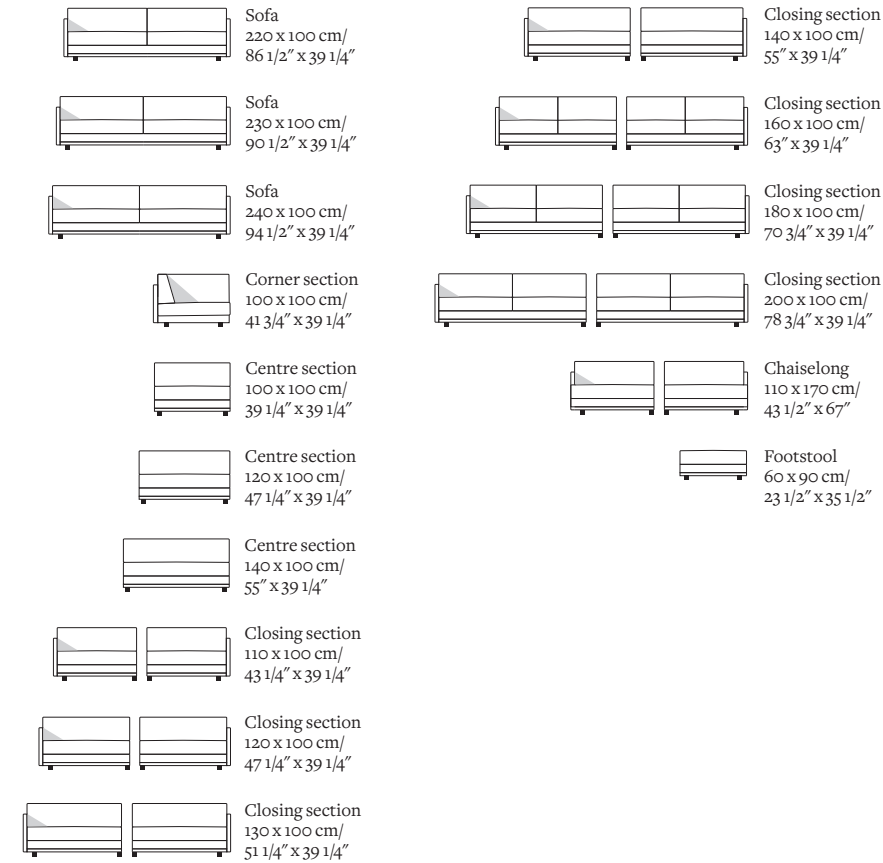

## Model Great Lift

Arm height: 60 cm / 23 1/2"

Arm width: 9 cm / 3 1/2"

Total depth (frame): 107 cm / 42 1/4"

Seat depth: 67 cm / 26 1/2"

Seat height: 43 cm / 17"

Total height (frame): 70/83 cm / 27 1/2"/32 3/4"

All overall dimensions correspond to frame sizes.

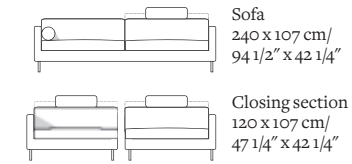

## Model Great Pampas depth 102 cm

Arm height: 56 cm / 22"

Arm width: 20 cm / 8"

Total depth (frame): 102 cm / 40 1/4"

Seat depth: 52 cm / 20 1/2"

Seat height: 38 cm / 15"

Total height (frame): 56 cm / 22"

All overall dimensions correspond to frame sizes.

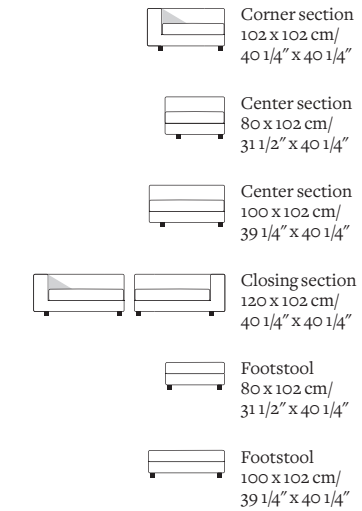

## Model Great Pampas depth 120 cm

Arm height: 56 cm / 22"

Arm width: 24 cm / 9 1/2"

Total depth (frame): 120 cm / 47 1/4"

Seat depth: 58 cm / 22 3/4"

Seat height: 38 cm / 15"

Total height (frame): 56 cm / 22"

All overall dimensions correspond to frame sizes.

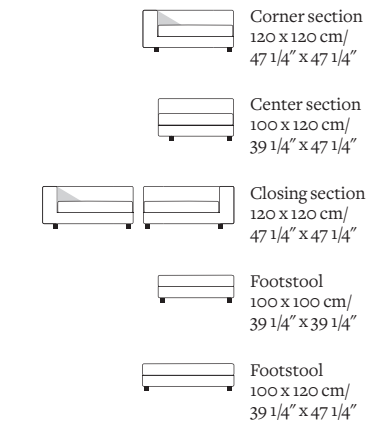

## Model High Box

Arm height: 65 cm / 25 1/2"

Arm width: 6 cm / 2 1/2"

Total depth (frame): 97 cm / 38 1/4"

Seat depth: 58 cm / 22 3/4"

Seat height: 40 cm / 15 3/4"

Total height (frame): 66 cm / 26"

All overall dimensions correspond to frame sizes.

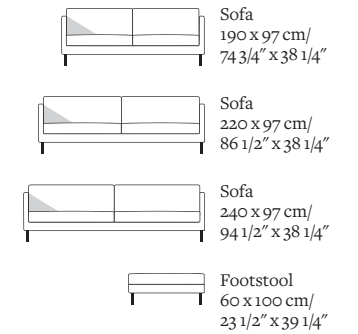



## Model Lift

Arm height: 60 cm / 23 1/2"

Arm width: 9 cm / 3 1/2"

Total depth (frame): 90 cm / 35 1/2"

Seat depth: 56 cm / 22"

Seat height: 43 cm / 17"

Total height (frame): 70/83 cm / 27 1/2"/32 3/4"

All overall dimensions correspond to frame sizes.

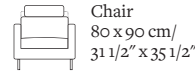

Chair  
80 x 90 cm/  
31 1/2" x 35 1/2"

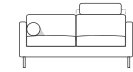

Sofa  
150 x 90 cm/  
59" x 35 1/2"



Sofa  
180 x 90 cm/  
70 3/4" x 35 1/2"

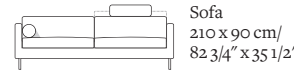

Sofa  
210 x 90 cm/  
82 3/4" x 35 1/2"

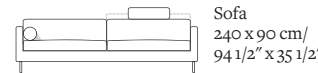

Sofa  
240 x 90 cm/  
94 1/2" x 35 1/2"

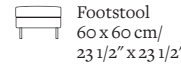

Footstool  
60 x 60 cm/  
23 1/2" x 23 1/2"

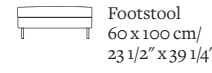

Footstool  
60 x 100 cm/  
23 1/2" x 39 1/4"

## Model Mission

Arm height: 66 cm / 26"

Arm width: 7 cm / 2 3/4"

Total depth (frame): 90 cm / 35 1/2"

Seat depth: 55 cm / 21 3/4"

Seat height: 44 cm / 17 1/4"

Total height (frame): 66 cm / 26"

All overall dimensions correspond to frame sizes.

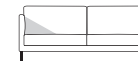

Sofa  
180 x 90 cm/  
70 3/4" x 35 1/2"

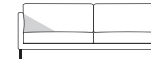

Sofa  
200 x 90 cm/  
78 3/4" x 35 1/2"

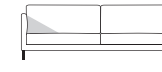

Sofa  
210 x 90 cm/  
82 3/4" x 35 1/2"

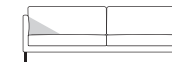

Sofa  
220 x 90 cm/  
86 1/2" x 35 1/2"

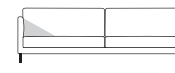

Sofa  
230 x 90 cm/  
90 1/2" x 35 1/2"

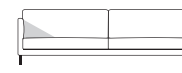

Sofa  
240 x 90 cm/  
94 1/2" x 35 1/2"

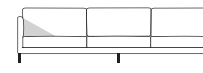

Sofa  
270 x 90 cm/  
106 1/4" x 35 1/2"



Corner section  
98 x 98 cm/  
38 1/2" x 38 1/2"



Center section  
100 x 90 cm/  
39 1/4" x 35 1/2"

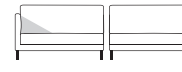

Closing section  
120 x 90 cm/  
47 1/4" x 35 1/2"

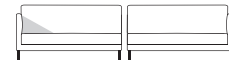

Closing section  
140 x 90 cm/  
55" x 35 1/2"

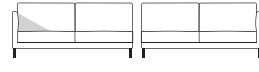

Closing section  
160 x 90 cm/  
63" x 35 1/2"



Closing section  
180 x 90 cm/  
70 3/4" x 35 1/2"

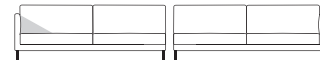

Closing section  
200 x 90 cm/  
78 3/4" x 35 1/2"

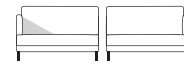

Chaiselong  
110 x 160 cm/  
43 1/4" x 63"



Footstool  
60 x 90 cm/  
23 1/2" x 35 1/2"

## Model Odense

Arm height: 53 cm / 20 3/4"

Arm width: 12 cm / 4 3/4"

Total depth (frame): 84 cm / 33"

Seat depth: 57 cm / 22 1/2"

Seat height: 44 cm / 17 1/4"

Total height (frame): 64 cm / 25 1/4"

All overall dimensions correspond to frame sizes.

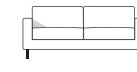

Sofa  
160 x 84 cm/  
63" x 33"



Sofa  
180 x 84 cm/  
70 3/4" x 33"

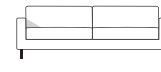

Sofa  
200 x 84 cm/  
78 3/4" x 33"

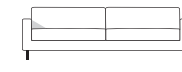

Sofa  
220 x 84 cm/  
86 1/2" x 33"



Sofa  
230 x 84 cm/  
90 1/2" x 33"

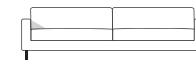

Sofa  
240 x 84 cm/  
94 1/2" x 33"

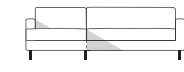

Sofa w. chaiselong  
210 x 144/84 cm/  
78 3/4" x 56 3/4" / 33"  
Chaise width: 80 cm / 31 1/2"

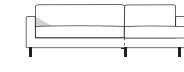

Sofa w. chaiselong  
210 x 144/84 cm/  
78 3/4" x 56 3/4" / 33"  
Chaise width: 80 cm / 31 1/2"

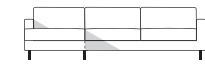

Sofa w. chaiselong  
210 x 144/84 cm/  
78 3/4" x 56 3/4" / 33"  
Chaise width: 80 cm / 31 1/2"



Sofa w. chaiselong  
240 x 144/84 cm/  
94 1/2" x 56 3/4" / 33"  
Chaise width: 80 cm / 31 1/2"



Footstool  
60 x 100 cm/  
23 1/2" x 39 1/4"



### Model Plano

Arm height: 61 cm / 24"  
 Arm width: 7 cm / 2 3/4"  
 Total depth (frame): 100 cm / 39 1/4"  
 Seat depth: 54 cm / 21 1/2"  
 Seat height: 40 cm / 15 3/4"  
 Total height (frame): 61 cm / 24"  
 All overall dimensions correspond to frame sizes.

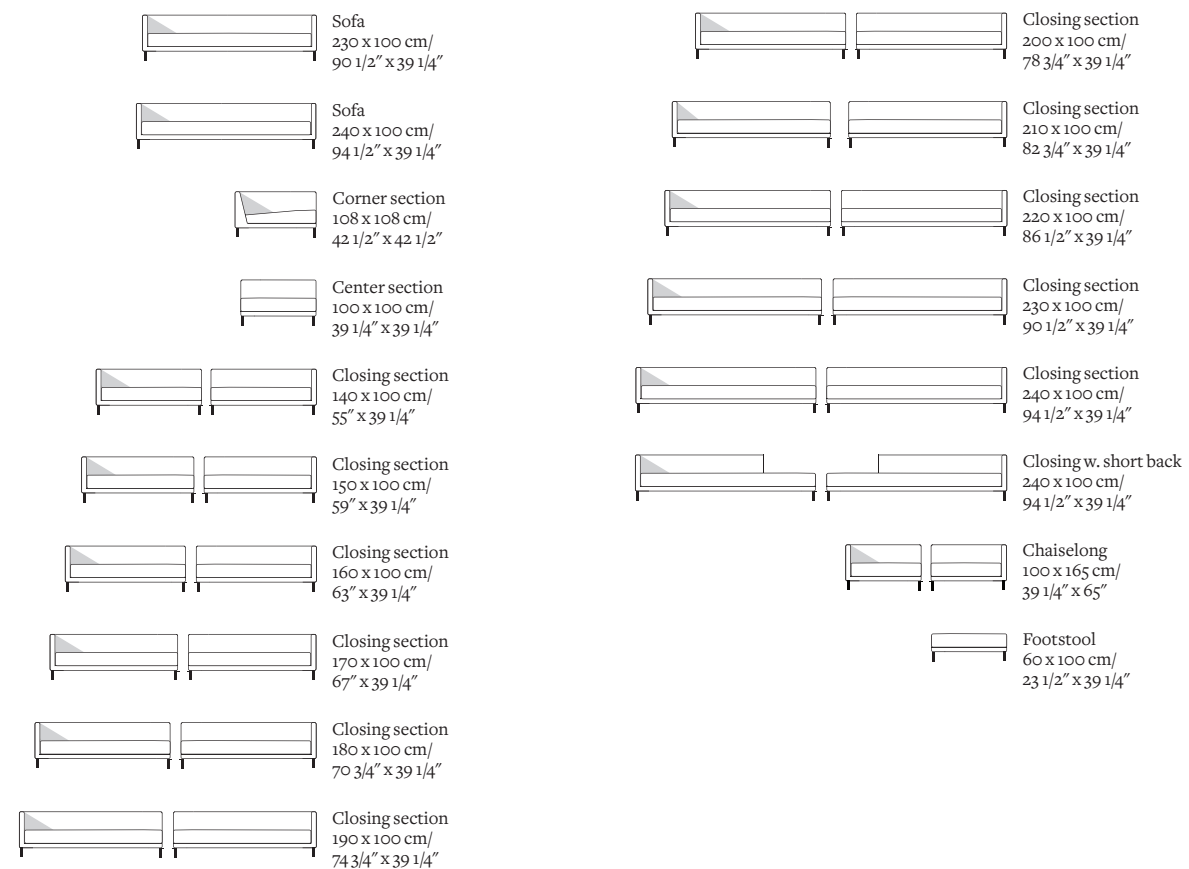

### Model Playground

Back support height: 32 cm / 12 1/2"  
 Seat height: 39 cm / 15 1/4"  
 All overall dimensions correspond to frame sizes.

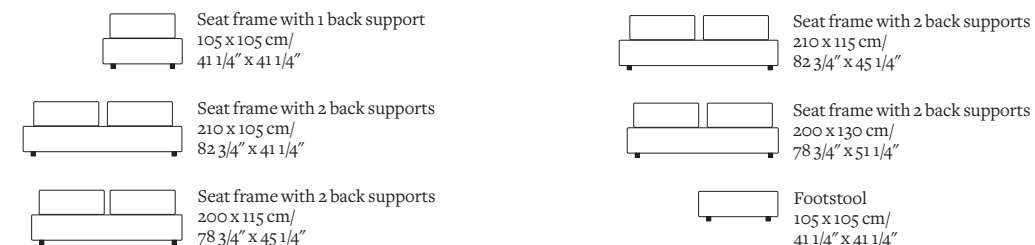



## Model Rig

Arm height: 67 cm / 26 1/2"

Arm width: 19 cm / 7 1/2"











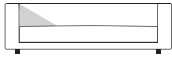
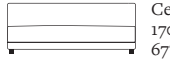

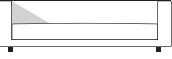
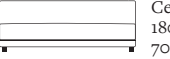

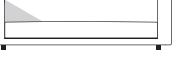
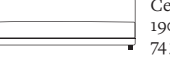

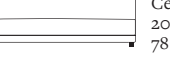

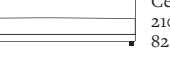

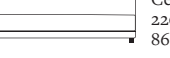



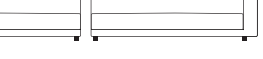

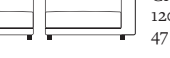
Total depth (frame): 100 cm / 39 1/4"





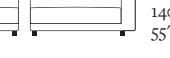

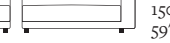





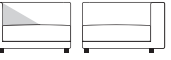

Seat depth: 60 cm / 23 1/2"

Seat height: 42 cm / 16 1/2"

Total height (frame): 67 cm / 26 1/2"

All overall dimensions correspond to frame sizes.



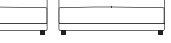







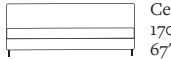
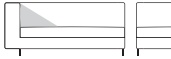
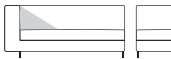

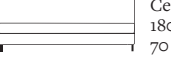
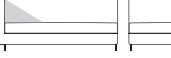





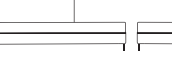

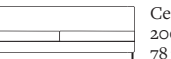



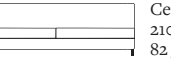





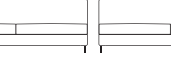









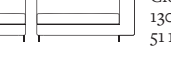

 Sofa 220 x 100 cm/ 86 1/2" x 39 1/4"	 Center section 170 x 100 cm/ 67" x 39 1/4"	 Closing section 160 x 100 cm/ 63" x 39 1/4"
 Sofa 230 x 100 cm/ 90 1/2" x 39 1/4"	 Center section 180 x 100 cm/ 70 3/4" x 39 1/4"	 Closing section 170 x 100 cm/ 67" x 39 1/4"
 Sofa 240 x 100 cm/ 94 1/2" x 39 1/4"	 Center section 190 x 100 cm/ 74 3/4" x 39 1/4"	 Closing section 180 x 100 cm/ 70 3/4" x 39 1/4"
 Corner section 100 x 100 cm/ 39 1/4" x 39 1/4"	 Center section 200 x 100 cm/ 78 3/4" x 39 1/4"	 Closing section 190 x 100 cm/ 74 3/4" x 39 1/4"
 Center section 100 x 100 cm/ 39 1/4" x 39 1/4"	 Center section 210 x 100 cm/ 82 3/4" x 39 1/4"	 Closing section 200 x 100 cm/ 78 3/4" x 39 1/4"
 Center section 110 x 100 cm/ 43 1/4" x 39 1/4"	 Center section 220 x 100 cm/ 86 1/2" x 39 1/4"	 Closing section 210 x 100 cm/ 82 3/4" x 39 1/4"
 Center section 120 x 100 cm/ 47 1/4" x 39 1/4"	 Closing section 110 x 100 cm/ 43 1/4" x 39 1/4"	 Closing section 220 x 100 cm/ 86 1/2" x 39 1/4"
 Center section 130 x 100 cm/ 51 1/4" x 39 1/4"	 Closing section 120 x 100 cm/ 47 1/4" x 39 1/4"	 Center with short back 160 x 100 cm/ 63" x 39 1/4"
 Center section 140 x 100 cm/ 55" x 39 1/4"	 Closing section 130 x 100 cm/ 51 1/4" x 39 1/4"	 Center with short back 170 x 100 cm/ 67" x 39 1/4"
 Center section 150 x 100 cm/ 59" x 39 1/4"	 Closing section 140 x 100 cm/ 55" x 39 1/4"	 Center with short back 180 x 100 cm/ 70 1/4" x 39 1/4"
 Center section 160 x 100 cm/ 63" x 39 1/4"	 Closing section 150 x 100 cm/ 59" x 39 1/4"	 Center with short back 190 x 100 cm/ 74 1/4" x 39 1/4"

 Center with short back 200 x 100 cm/ 78 3/4" x 39 1/4"	 Footstool 60 x 100 cm/ 23 1/2" x 39 1/4"
 Chaiselong with arm 100 x 170 cm/ 39 1/4" x 67"	 Footstool 60 x 80 cm/ 23 1/2" x 31 1/2"
 Chaiselong with arm 110 x 170 cm/ 43 1/4" x 67"	 Footstool 100 x 100 cm/ 39 1/4" x 39 1/4"
 Chaiselong with arm 120 x 170 cm/ 47 1/4" x 67"	 Footstool 100 x 150 cm/ 39 1/4" x 59"
 Chaiselong with arm 130 x 170 cm/ 51 1/4" x 67"	
 Chaiselong with arm 140 x 170 cm/ 55" x 67"	
 Chaiselong without arm 100 x 170 cm/ 39 1/4" x 67"	
 Chaiselong without arm 110 x 170 cm/ 43 1/4" x 67"	
 Chaiselong without arm 120 x 170 cm/ 47 1/4" x 67"	
 Chaiselong without arm 130 x 170 cm/ 51 1/4" x 67"	
 Chaiselong without arm 140 x 170 cm/ 55" x 67"	

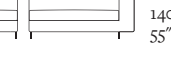
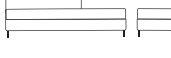
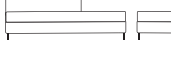

### Model Savanna

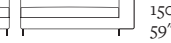
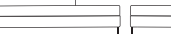
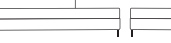
Arm height: 68 cm / 26 3/4"  
 Arm width: 20 cm / 7 1/2"  
 Total depth (frame): 100 cm / 39 1/4"  
 Seat depth: 57 cm / 22 1/2"  
 Seat height: 42 cm / 16 1/2"  
 Total height (frame): 68 cm / 26 3/4"  
 All overall dimensions correspond to frame sizes.

	Sofa 220 x 100 cm/ 86 1/2" x 39 1/4"		Center section 170 x 100 cm/ 67" x 39 1/4"		Closing section 160 x 100 cm/ 63" x 39 1/4"		Closing section 160 x 100 cm/ 63" x 39 1/4"		Center w/short back 180 x 100 cm/ 70 1/4" x 39 1/4"
	Sofa 230 x 100 cm/ 90 1/2" x 39 1/4"		Center section 180 x 100 cm/ 70 3/4" x 39 1/4"		Closing section 170 x 100 cm/ 67" x 39 1/4"		Closing section 170 x 100 cm/ 67" x 39 1/4"		Center with short back 190 x 100 cm/ 74 1/4" x 39 1/4"
	Sofa 240 x 100 cm/ 94 1/2" x 39 1/4"		Center section 190 x 100 cm/ 74 3/4" x 39 1/4"		Closing section 180 x 100 cm/ 70 3/4" x 39 1/4"		Closing section 180 x 100 cm/ 70 3/4" x 39 1/4"		Center with short back 200 x 100 cm/ 78 3/4" x 39 1/4"
	Corner section 108 x 108 cm/ 42 1/2" x 42 1/2"		Center section 200 x 100 cm/ 78 3/4" x 39 1/4"		Closing section 190 x 100 cm/ 74 3/4" x 39 1/4"		Closing section 190 x 100 cm/ 74 3/4" x 39 1/4"		Chaiselong with arm 100 x 170 cm/ 39 1/4" x 67"
	Center section 100 x 100 cm/ 39 1/4" x 39 1/4"		Center section 210 x 100 cm/ 82 3/4" x 39 1/4"		Closing section 200 x 100 cm/ 78 3/4" x 39 1/4"		Closing section 200 x 100 cm/ 78 3/4" x 39 1/4"		Chaiselong with arm 110 x 170 cm/ 43 1/4" x 67"
	Center section 110 x 100 cm/ 43 1/4" x 39 1/4"		Center section 220 x 100 cm/ 86 1/2" x 39 1/4"		Closing section 210 x 100 cm/ 82 3/4" x 39 1/4"		Closing section 210 x 100 cm/ 82 3/4" x 39 1/4"		Chaiselong with arm 120 x 170 cm/ 47 1/4" x 67"
	Center section 120 x 100 cm/ 47 1/4" x 39 1/4"		Closing section 110 x 100 cm/ 43 1/4" x 39 1/4"		Closing section 220 x 100 cm/ 86 1/2" x 39 1/4"		Closing section 220 x 100 cm/ 86 1/2" x 39 1/4"		Chaiselong with arm 130 x 170 cm/ 51 1/4" x 67"
	Center section 130 x 100 cm/ 51 1/4" x 39 1/4"		Closing section 120 x 100 cm/ 47 1/4" x 39 1/4"		Closing section 230 x 100 cm/ 90 1/2" x 39 1/4"		Closing section 230 x 100 cm/ 90 1/2" x 39 1/4"		Chaiselong with arm 140 x 170 cm/ 55" x 67"
	Center section 140 x 100 cm/ 55" x 39 1/4"		Closing section 130 x 100 cm/ 51 1/4" x 39 1/4"		Closing section 240 x 100 cm/ 94 1/2" x 39 1/4"		Closing section 240 x 100 cm/ 94 1/2" x 39 1/4"		Chaiselong without arm 120 x 170 cm/ 47 1/4" x 67"
	Center section 150 x 100 cm/ 59" x 39 1/4"		Closing section 140 x 100 cm/ 55" x 39 1/4"		Center w/short back 160 x 100 cm/ 63" x 39 1/4"		Center w/short back 160 x 100 cm/ 63" x 39 1/4"		Footstool 60 x 100 cm/ 23 1/2" x 39 1/4"
	Center section 160 x 100 cm/ 63" x 39 1/4"		Closing section 150 x 100 cm/ 59" x 39 1/4"		Center w/short back 170 x 100 cm/ 67" x 39 1/4"		Center w/short back 170 x 100 cm/ 67" x 39 1/4"		Footstool 100 x 100 cm/ 39 1/4" x 39 1/4"



## Model Session

Arm height: 65,5 cm / 25 1/4"

Arm width: 3,5 cm / 1 1/2"

Total depth (frame): 92 cm / 35 1/2"

Seat depth: 55 cm / 36 1/4"

Seat height: 46 cm / 18"

Total height (frame): 65,5 cm / 25 3/4"

All overall dimensions correspond to frame sizes.

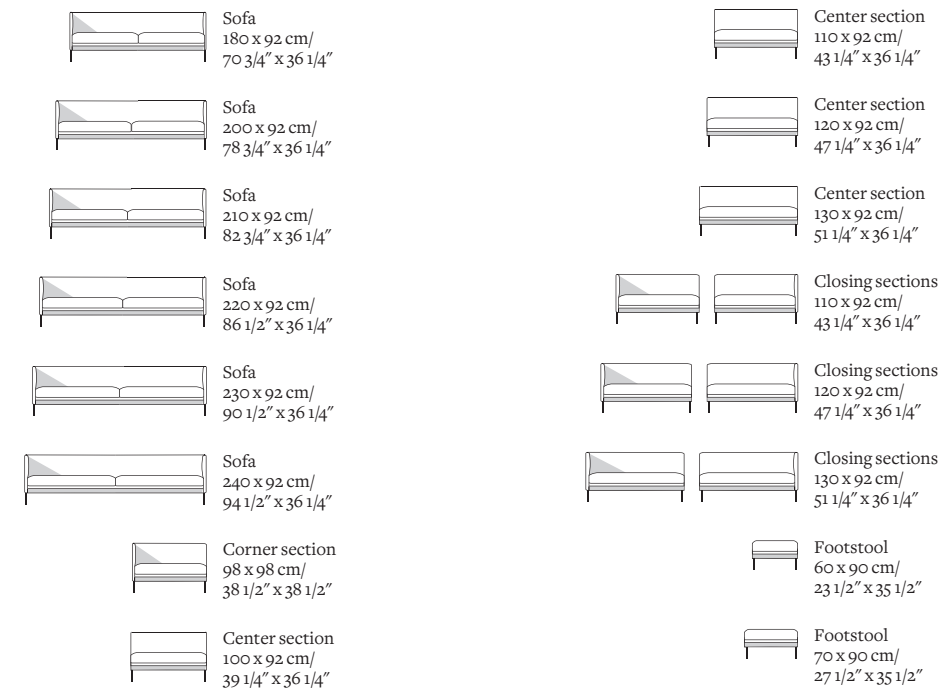

## Model Skagen

Arm height: 64 cm / 25 1/4"

Arm width: 5 cm / 2"

Total depth (frame): 85 cm / 33 1/2"

Seat depth: 51 cm / 20"

Seat height: 42 cm / 15 1/2"

Total height (frame): 75 cm / 29 1/2"

All overall dimensions correspond to frame sizes.

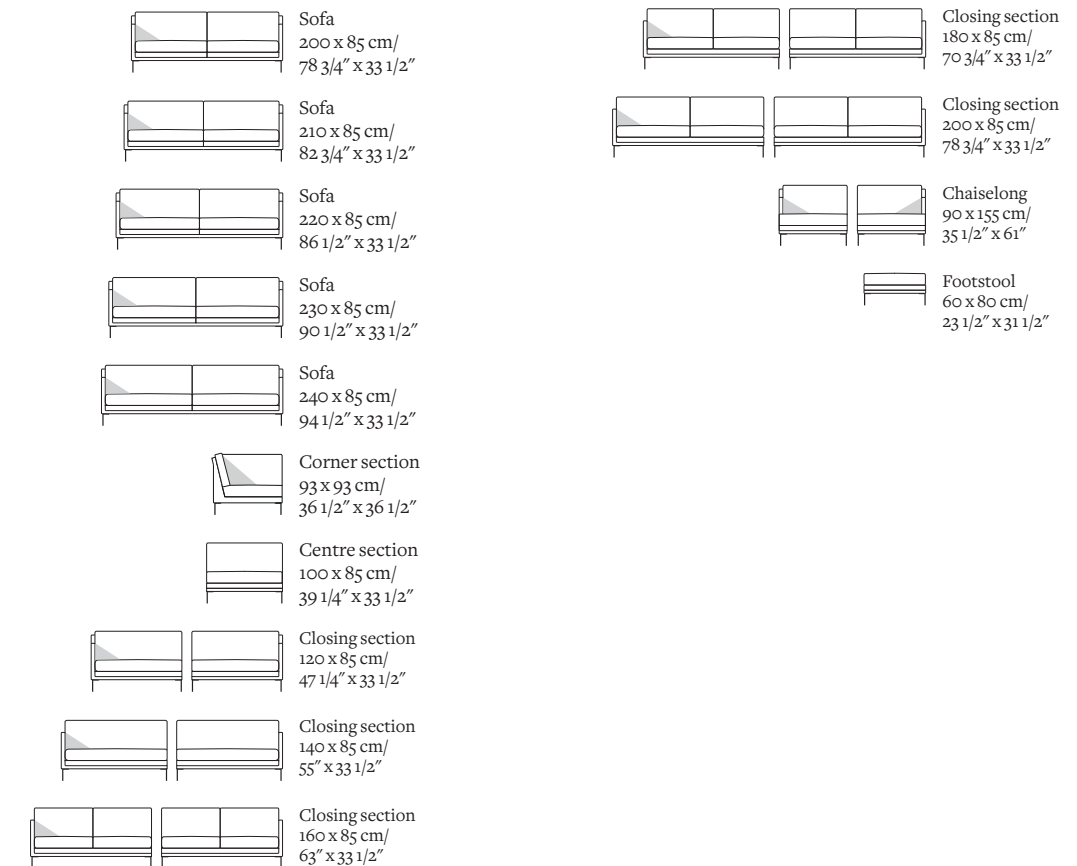



## Model Slice

Arm height: 61 cm / 24"

Arm width: 9 cm / 3 1/2"

Total depth (frame): 86 cm / 33 3/4"

Seat depth: 55 cm / 21 3/4"

Seat height: 43 cm / 17"

Total height (frame): 68 cm / 26 3/4"

All overall dimensions correspond to frame sizes.



Chair  
80 x 86 cm/  
31 1/2" x 33 3/4"



Sofa  
180 x 86 cm/  
70 3/4" x 33 3/4"

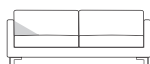

Sofa  
190 x 86 cm/  
74 3/4" x 33 3/4"



Sofa  
200 x 86 cm/  
78 3/4" x 33 3/4"



Sofa  
210 x 86 cm/  
82 3/4" x 33 3/4"

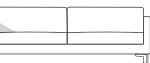

Sofa  
220 x 86 cm/  
86 1/2" x 33 3/4"



Sofa  
230 x 86 cm/  
90 1/2" x 33 3/4"

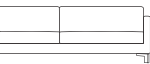

Sofa  
240 x 86 cm/  
94 1/2" x 33 3/4"



Footstool  
50 x 70 cm/  
19 1/4" x 27 1/2"



Footstool  
60 x 100 cm/  
23 1/2" x 39 1/4"

## Model Slimline

Arm height: 59 cm / 23 1/4"

Arm width: 3,5 cm / 1 1/2"

Arm cushion width: 12 cm / 4 3/4"

Total depth (frame): 92 cm / 36 1/4"

Seat depth: 62 cm / 24 1/4"

Seat height: 47 cm / 18 1/2"

Total height (frame): 67 cm / 26 1/2"

All overall dimensions correspond to frame sizes.

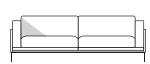

Sofa  
180 x 92 cm/  
70 3/4" x 36 1/4"

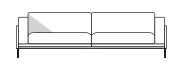

Sofa  
200 x 92 cm/  
78 3/4" x 36 1/4"

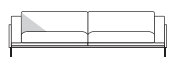

Sofa  
210 x 92 cm/  
82 3/4" x 36 1/4"

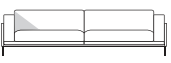

Sofa  
220 x 92 cm/  
86 1/2" x 36 1/4"

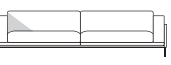

Sofa  
230 x 92 cm/  
90 1/2" x 36 1/4"

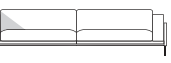

Sofa  
240 x 92 cm/  
94 1/2" x 36 1/4"



Corner section  
100 x 100 cm/  
39 1/4" x 39 1/4"



Center section  
100 x 92 cm/  
39 1/4" x 36 1/4"



Center section  
110 x 92 cm/  
43 1/4" x 36 1/4"



Center section  
120 x 92 cm/  
47 1/4" x 36 1/4"



Center section  
130 x 92 cm/  
51 1/4" x 36 1/4"

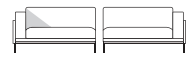

Closing sections  
110 x 92 cm/  
43 1/4" x 36 1/4"

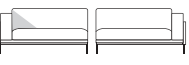

Closing sections  
120 x 92 cm/  
47 1/4" x 36 1/4"

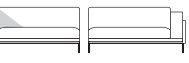

Closing sections  
130 x 92 cm/  
51 1/4" x 36 1/4"



Footstool  
60 x 90 cm/  
23 1/2" x 35 1/2"



Footstool  
70 x 90 cm/  
27 1/2" x 35 1/2"

## Model Slope

Arm height: 60 cm / 23 1/2"

Arm width: 6 cm / 2 1/4"

Total depth (frame): 100 cm / 39 1/4"

Seat depth: 50/68 cm / 19 3/4" / 26 3/4"

Seat height: 40 cm / 15 3/4"

Total height (frame): 60 cm / 23 1/2"

All overall dimensions correspond to frame sizes.

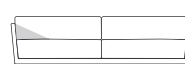

Sofa  
240 x 100 cm/  
94 1/2" x 39 1/4"



Corner section  
100 x 100 cm/  
39 1/4" x 39 1/4"



Center section  
100 x 100 cm/  
39 1/4" x 39 1/4"



Center section  
110 x 100 cm/  
43 1/4" x 39 1/4"



Center section  
120 x 100 cm/  
47 1/4" x 39 1/4"



Center section  
130 x 100 cm/  
51 1/4" x 39 1/4"



Closing section  
110 x 100 cm/  
43 1/4" x 39 1/4"



Closing section  
120 x 100 cm/  
47 1/4" x 39 1/4"



Closing section  
130 x 100 cm/  
51 1/4" x 39 1/4"



Closing section  
140 x 100 cm/  
55" x 39 1/4"



Center section w. short back  
160 x 100 cm/  
63" x 39 1/4"



Center section w. short back  
180 x 100 cm/  
70 3/4" cm x 39 1/4"



Center section w. short back  
200 x 100 cm/  
78 3/4" cm x 39 1/4"



Chaiselong  
110 x 170 cm/  
43 1/4" x 67"



Footstool  
60 x 100 cm/  
23 1/2" x 39 1/4"



Footstool  
70 x 100 cm/  
27 1/2" x 39 1/4"



Footstool  
80 x 100 cm/  
31 1/2" x 39 1/4"



## Model Streamline

Arm height: 58 cm / 22 3/4"

Arm width: 9 cm / 3 1/2"

Total depth (frame): 91 cm / 35 3/4"

Seat depth: 55 cm / 21 3/4"

Seat height: 42 cm / 16 1/2"

Total height (frame): 71 cm / 28"

All overall dimensions correspond to frame sizes.



Chair  
80 x 91 cm/  
31 1/2" x 35 3/4"



Sofa  
150 x 91 cm/  
59" x 35 3/4"



Sofa  
160 x 91 cm/  
63" x 35 3/4"



Sofa  
170 x 91 cm/  
67" x 35 3/4"



Sofa  
180 x 91 cm/  
70 3/4" x 35 3/4"



Sofa  
190 x 91 cm/  
74 3/4" x 35 3/4"



Sofa  
200 x 91 cm/  
78 3/4" x 35 3/4"



Sofa  
210 x 91 cm/  
82 3/4" x 35 3/4"



Sofa  
220 x 91 cm/  
86 1/2" x 35 3/4"



Sofa  
230 x 91 cm/  
90 1/2" x 35 3/4"



Sofa  
240 x 91 cm/  
94 1/2" x 35 3/4"



Sofa with chaiselong  
190 x 151/91 cm/  
74 3/4" x 59 1/2" / 35 3/4"  
Chaise. width: 80 cm / 31 1/2"



Sofa with chaiselong  
200 x 151/91 cm/  
78 3/4" x 59 1/2" / 35 3/4"  
Chaise. width: 80 cm / 31 1/2"



Sofa with chaiselong  
210 x 151/91 cm/  
82 3/4" x 59 1/2" / 35 3/4"  
Chaise. width: 80 cm / 31 1/2"



Sofa with chaiselong  
220 x 151/91 cm/  
86 1/2" x 59 1/2" / 35 3/4"  
Chaise. width: 80 cm / 31 1/2"



Sofa with chaiselong  
230 x 151/91 cm/  
90 1/2" x 59 1/2" / 35 3/4"  
Chaise. width: 80 cm / 31 1/2"

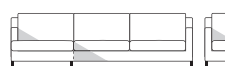

Sofa with chaiselong  
240 x 151/91 cm/  
94 1/2" x 59 1/2" / 35 3/4"  
Chaise. width: 80 cm / 31 1/2"



Corner section  
98 x 98 cm/  
38 1/2" x 38 1/2"



Closing section  
110 x 91 cm/  
43 1/4" x 35 3/4"



Closing section  
120 x 91 cm/  
47 1/4" x 35 3/4"



Closing section  
130 x 91 cm/  
51 1/4" x 35 3/4"



Closing section  
140 x 91 cm/  
55" x 35 3/4"



Closing section  
150 x 91 cm/  
59" x 35 3/4"



Closing section  
160 x 91 cm/  
63" x 35 3/4"



Closing section  
170 x 91 cm/  
67" x 35 3/4"



Closing section  
180 x 91 cm/  
70 3/4" x 35 3/4"



Closing section  
190 x 91 cm/  
74 1/4" x 35 3/4"



Closing section  
210 x 91 cm/  
82 1/4" x 35 3/4"



Chaiselong  
80 x 151 cm/  
31 1/2" x 59 1/2"



Footstool  
60 x 60 cm/  
23 1/2" x 23 1/2"



Footstool  
60 x 100 cm/  
23 1/2" x 39 1/4"



## Model Tub

Arm height: 58.5 cm / 23"

Arm width: 7 cm / 2 3/4"

Arm cushion width: 20 cm / 7 1/2"

Total depth (frame): 94 and 104 cm / 37"/41"

Seat depth: 55/65 cm / 21 3/4"/25 1/2"

Seat height: 40 cm / 15 3/4"

Total height (frame): 58.5 cm / 23"

All overall dimensions correspond to frame sizes.



Chair  
120 x 94 cm/  
47 1/4" x 37"



Sofa  
180 x 94 cm/  
70 3/4" x 37"

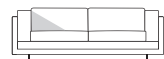

Sofa  
200 x 94 cm/  
78 3/4" x 37"



Sofa  
220 x 94 cm/  
86 1/2" x 37"

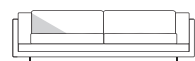

Sofa  
240 x 94 cm/  
94 1/2" x 37"



Corner section  
94 x 94 cm/  
37" x 37"



Corner section  
Left 94 x right 104 cm/  
Left 37" x right 41"



Corner section  
Left 104 x right 94 cm/  
Left 41" x right 37"



Corner section  
104 x 104 cm/  
41" x 41"



Center section  
100 x 94/104 cm/  
39 1/4" x 37"/41"



Closing section  
110 x 94/104 cm/  
43 1/4" x 37"/41"



Closing section  
120 x 94/104 cm/  
47 1/4" x 37"/41"



Closing section  
130 x 94/104 cm/  
51 1/4" x 37"/41"



Closing section  
150 x 94/104 cm/  
59" x 37"/41"



Closing section  
170 x 94/104 cm/  
67" x 37"/41"



Closing section  
190 x 94/104 cm/  
74 3/4" x 37"/41"



Closing section  
210 x 94/104 cm/  
82 3/4" x 37"/41"



Closing section  
220 x 104 cm/  
86 1/2" x 41"



Closing section  
230 x 94 cm/  
90 1/2" x 37"



Chaiselong  
100 x 154 cm/  
39 1/4" x 60 3/4"



Chaiselong  
110 x 164 cm/  
43 1/4" x 64 1/2"



Footstool  
60 x 80 cm/  
23 1/2" x 31 1/2"



Footstool  
60 x 100 cm/  
23 1/2" x 39 1/4"

## Model Zenith

Arm height: 64 cm / 25 1/4"

Arm width: 12 cm / 4 3/4"

Total depth (frame): 100 and 110 cm / 39 1/4"/43 1/4"

Seat depth: 63/73 cm / 24 3/4"/28 3/4"

Seat height: 40 cm / 15 3/4"

Total height (frame): 64 cm / 25 1/4"

All overall dimensions correspond to frame sizes.



Chair  
84 x 100 cm/  
33" x 39 1/4"



Sofa  
180 x 100 cm/  
70 3/4" x 39 1/4"



Sofa  
200 x 100 cm/  
78 3/4" x 39 1/4"



Sofa  
220 x 100 cm/  
86 1/2" x 39 1/4"



Sofa  
240 x 100 cm/  
94 1/2" x 39 1/4" / 43 1/4"

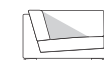

Corner section  
108 x 108 cm/  
42 1/2" x 42 1/2"



Closing section  
140 x 100 cm/  
55" x 39 1/4"



Closing section  
200 x 100 cm/  
78 3/4" x 39 1/4"



Footstool  
50 x 70 cm/  
19 3/4" x 37 1/2"

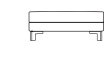

Footstool  
50 x 100 cm/  
19 3/4" x 39 1/4"

## Model Ashton

Arm height: 62 cm / 24 1/2"

Arm width: 5 cm / 2"

Total depth (frame): 82 cm / 32 1/4"

Seat depth: 53 cm / 20 3/4"

Seat height: 45 cm / 15 3/4"

Total height (frame): 73 cm / 28 3/4"

All overall dimensions correspond to frame sizes.



Chair  
70 x 82 cm/  
27 1/2" x 32 1/4"

## Model Safari

Chair



Chair  
61 x 61 cm/  
24" x 24"

The chair is offered in core leather Saddle in following colors:  
- Core leather Saddle: Color #23 (light), #03 (cognac), #10 (black)

Available colour and material on frame:

- Oak, nature oil treated.
- Oak, nature soap treated.
- Oak, black stained.



## Model Stable

Arm height: 66 cm / 26"

Arm width: 5 cm / 2"

Total depth (frame): 80 cm / 31 1/2"

Seat depth: 53 cm / 20 3/4"

Seat height: 37 cm / 14 1/2"

Total height (frame): 66 cm / 26"

All overall dimensions correspond to frame sizes.



Chair  
71 x 80 cm/  
28" x 31 1/2"

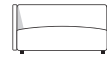

Sofa  
130 x 80 cm/  
51 1/4" x 31 1/2"

## Model Circus

Table

Table height Ø40: 31 cm/12 1/4"

Table height Ø40: 38 cm/15"

Table height Ø60: 31 cm/12 1/4"

Table height Ø60: 38 cm/15"



Table  
Ø40 cm / 15 3/4"



Table  
Ø40 cm / 15 3/4"



Table  
Ø60 cm / 23 1/2"



Table  
Ø60 cm / 23 1/2"

- Choose any table top from the standard collection of glass, marble, granite, travertine and onyx table tops.

## Model Frame

Table

Table height: 38 cm / 15"

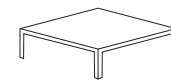

Sofa table  
100 x 100 cm/  
39 1/4" x 39 1/4"

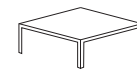

Sofa table  
80 x 80 cm/  
31 1/2" x 31 1/2"

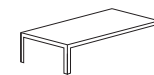

Sofa table  
60 x 120 cm/  
23 1/2" x 27 1/4"

- Choose any table top from the standard collection of glass, marble, granite, travertine and onyx table tops.

- Frame can be delivered with either one or two table tops

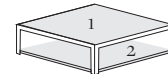

## Model Kant

Table



Sofa table  
120 x 60,5 x 42 cm/  
47 1/4" x 23 3/4" x 16 1/2"

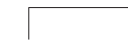

Sofa table  
150 x 60,5 x 42 cm/  
59" x 23 3/4" x 16 1/2"



Sofa table  
150 x 60,5 x 30 cm/  
59" x 23 3/4" x 11 3/4"

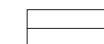

Console table with shelf  
120 x 30 x 55 cm/  
47 1/4" x 11 3/4" x 21 3/4"

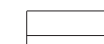

Console table with shelf  
120 x 30 x 65 cm/  
47 1/4" x 11 3/4" x 25 1/2"

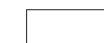

Console table  
120 x 30 x 70 cm/  
47 1/4" x 11 3/4" x 27 1/2"



Support table  
30 x 70 x 35 cm/  
11 3/4" x 27 1/2" x 13 3/4"



Bench  
70 x 30 x 42 cm/  
27 1/2" x 11 3/4" x 16 1/2"

Available material:  
- Oak

## Model Island

Table



Sofa table  
100 x 120 cm/  
39 1/4" x 47 1/4"



Sofa table  
120 x 140 cm/  
47 1/4" x 55"



Sofa table  
140 x 160 cm/  
55" x 63"

Available color and material:  
- White marble base with chromated frame in height 22,5 or 32,5 cm and 20 mm white marble table top



## Model Spider

Table

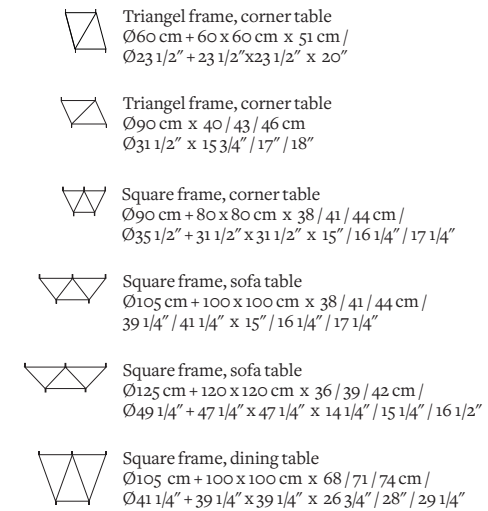

Available colour and material:

- Matt black lacquered steel frame (RAL 9004)
- Matt white lacquered steel frame (RAL 9002)
- Racing Green lacquered steel frame (RAL 6009)
- Rust lacquered steel frame (RAL 3009)
- Fog lacquered steel frame (RAL 7033)
- Shiny chromed steel frame
- Brushed stainless steel frame
- Brass frame

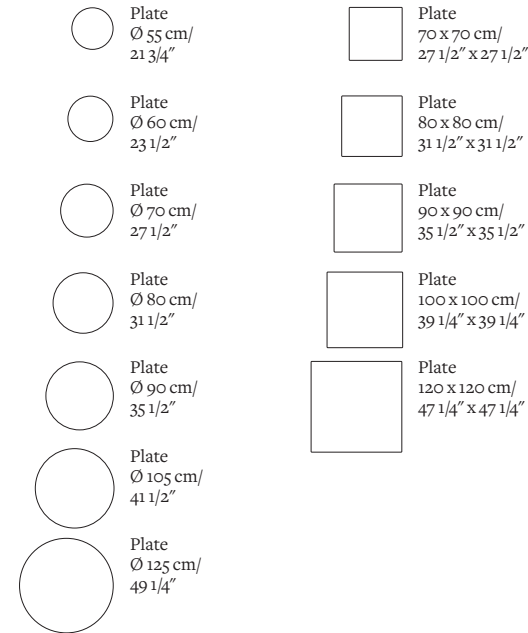

Available colour and material

- Glass tops: Transparent, tinted green, tinted brown colored (forest green, peach pink, cloudy white, smokey grey, nordic noir)

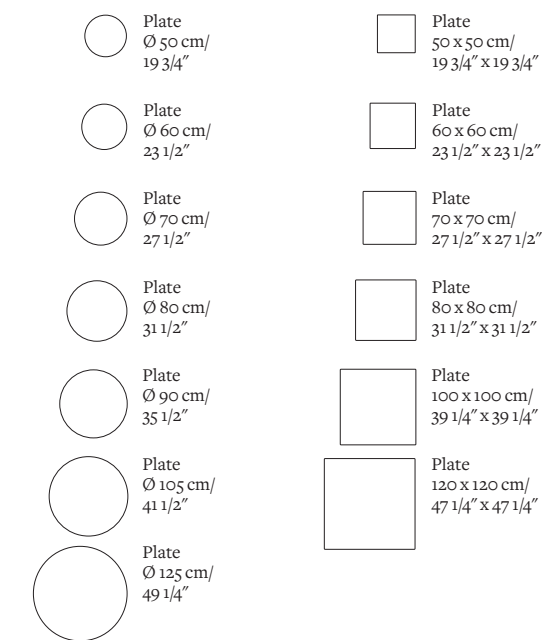

Available colour and material

- Marble tops: Green, white, black/white, pink, yellow, golden, wodden, Kudu gray, purple gray (not available in size Ø125 and 120 x 120 cm), brown (not available in size Ø105, Ø125, 100 x 100 cm and 120 x 120 cm)
- Granite tops: Black
- Onyx tops: Green (not available in size Ø105, Ø125, 100 x 100 cm and 120 x 120 cm)
- Travertine tops: Sand

## Model Puzzle

Table

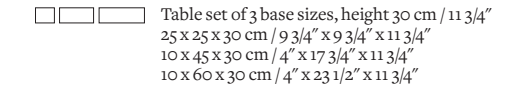

Available material and colour:

- Acacia wood.
- PU lack, added some brown color.
- Black stained.



## Model Bag

Footstool

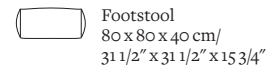

Footstool  
80 x 80 x 40 cm/  
31 1/2" x 31 1/2" x 15 3/4"



Footstool  
100 x 100 x 40 cm/  
39 1/4" x 39 1/4" x 15 3/4"

## Model Wheel

Footstool

With one or more bottoms



Footstool  
Ø60 x 33 cm/  
Ø23 1/2" x 13"



Footstool  
Ø80 x 33 cm/  
Ø31 1/2" x 13"



Footstool  
Ø100 x 33 cm/  
Ø39 1/4" x 13"



Footstool  
Ø120 x 33 cm/  
Ø47 1/4" x 13"

## Model Bun

Footstool



Footstool  
40 x 40 x 40 cm/  
15 3/4" x 15 3/4" x 15 3/4"

## Model Stick

Carpet



Carpet  
140 x 200 cm/  
55" x 78 3/4"



Carpet  
170 x 240 cm/  
67" x 94 1/2"



Carpet  
200 x 300 cm/  
78 3/4" x 118"



Carpet  
250 x 350 cm/  
98 1/2" x 137 3/4"

## Model Square

Footstool



Footstool  
60 x 100 x 33 cm/  
23 1/2" x 39 1/4" x 13"

## Model Field

Carpet



Carpet  
80 x 250 cm/  
31 1/2" x 98 1/2"



Carpet  
140 x 200 cm/  
55" x 78 3/4"



Carpet  
170 x 240 cm/  
67" x 94 1/2"

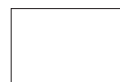

Carpet  
200 x 300 cm/  
78 3/4" x 118"

# List of accessories

PAGE 24:

On the table from left:

Vase: Kate Kanstrup

Plate: Tasja P. Ceramics

On small table:

White plaster object: Josphine Alberthe

Round bonbonniere: Frama

Small round plate: Tasja P. Ceramics

Wooden object on the floor: A Hint of Neon

Big plaster object: Josphine Alberthe

On marble cube:

Table lamp: Munk Collective

Book: Private

Wooden sculpture: Ole Wettergren

Pitcher: Frama

Canvas: Private

PAGE 28

From the left:

Side table in metal: Munk Collective

Small print on the wall: Private

Painting on the wall: Private

On coffee table from the left:

Table lamp: Sacre Coeur

Small dish shaped as a clam: Hay

Glass dish: Helle Mardahl

Plaid on footstool: Tine K Home

PAGE 32:

From left:

Mirror object: Birger1962

In the windowsill:

Vase in metal: Tableau-cph

Vase: 101 Cph

Sculpture in stone on pedestal: Ole Herold

Mynster

On coffee table:

Small jar: Meyer-Lavigne

Wooden sculpture: Black Cph

Books: Private

Plaid: Tine K Home

In the windowsill:

Large ceramic vase: RAN Keramik

Bowl on a frame: 101 Cph

Small vase: RAN Keramik

Yellow vase: Anna Bystrup Jensen

Table lamp: 101 cph

PAGE 34:

Lamp on the floor: Karkater Copenhagen

Picture on the wall: Mintstudio

On marble cube:

Plate: Menu

Porcelain sculpture: Kate Kanstrup

On the sofa table from left:

Books: Private

Vase: Karin Blach Nielsen

Porcelain vase: Kate Kanstrup

Plate: Josephine Alberthe

Floor lamp: Anker & Co

Picture: Mint studio

PAGE 38:

Picture on the floor: Mintstudio

On the table from left:

Table lamp: Helle Mardahl

Tall vase: Karin Blach Nielsen

Grey Vase: Yonobi

Book: Private

Marble ball: Private

Floor lamp: Flos

On the table from left:

Ceramic object: Kate Kanstrup

Tall vase: Karin Blach Nielsen

Cup: Stilleben

Spoon: Private

Stool: Rasmus Fenhann

Art piece on the wall: Private

PAGE 42:

Glass sculpture: Sigrid Buus

Mirror: Troels Flensted

Bowl: Yonobi

Ball: private

Table lamp: Christine Callsen Interieur

Picture: The Poster Club

PAGE 46:

On sofa table:

Book: Private

Chrome trivet: Arket

Porcelain sculpture: Kate Kanstrup

Small side table: Frama

On table:

Vase: Trine Birgitte Bond

Under table:

Vase: 101cph

Books: Private

On console table from left:

Table lamp: &tradition

Picture: Meyer Lavigne

Ceramic object: Private

Books: Private

Small white vase: Yonobi

Tall vase: Hay

Black vase: Karin Blach

Picture: The Poster Club

Floor lamp: Boffi

PAGE 50:

From left:

On coffee table:

Candlestick: Ferm Living

Plate: Anna Bystrup Jensen



Small vase: Studio Arhøj  
 Big vase: Tortus Copenhagen  
 At the bottom:  
 Vase: Private  
 Books: Private  
 Lamp: Flos  
 Chair: Frama  
 On marble table:  
 Wooden jar: Kristina Dam Studio  
 Books: Private  
 Elongated wooden tray: Mater Design  
 Ceramic object: Maria Lenskjold

PAGE 54:  
 Pictures: The Poster Club  
 Marble block: Menu  
 Mirror: Czyk  
 Lamp on floor: Frandsen Lightning  
 Lamp on sideboard: Flos

PAGE 58:  
 From left:  
 Floor lamp: 101 Cph  
 In the windowsill:  
 Vase: Tortus Copenhagen  
 Small jar: Anna Bystrup Jensen  
 Metal vase: Tableau-cph  
 Ceramic sculpture: RAN keramik  
 Small round table: 101 Cph  
 Photos: Paper Collective  
 Magazine: Private

PAGE 62:  
 From left:  
 Painting: Private  
 Pedestal Private  
 Sculpture: Anna Bystrup Jensen  
 Books Private

Sculpture on pedestal: Meyer-Lavigne  
 Wall decoration in wood: Kristina Dam Studio  
 On table from left:  
 Vase: Tortus Copenhagen  
 Ceramic mask: Meyer-Lavigne  
 Small cup: Anna Bystrup Jensen  
 Table lamp: 101 Cph

PAGE 66:  
 Carpet: Linie Design  
 Metal table: Tom Dixon, Roomstore  
 Mirror: Area Store  
 Metal jar: H&M Home  
 Jug: Rue Verte Plus  
 Glass bowl: Vintage

PAGE 68:  
 Blanket in sofa: Louise Roe  
 Small table: Aytm  
 Bookends on table: Menu  
 Marble ball: Röd Studio  
 Lamp: Flos

PAGE 72:  
 Ball: Kaja Skytte  
 Bust: Kristiina  
 Vase: Yonobi  
 Cup: Yonobi  
 Painting: Anne Aarsland  
 Floor lamp: Handværk  
 Big grafic painting: Idoart

PAGE 74:  
 Art on wall from left:  
 Stripes: Kristina Krogh Studio  
 Red and green picture: Private  
 Ellipse mirror: Aytm  
 Black and white stripes: Au Maison

Picture with feathers: Kristina Krogh Studio  
 Brass sculpture: Kaja Skytte  
 Grafic art: Paper Collective  
 Big round mirror: Aytm  
 Splash photo: Private  
 Grafic art squares: Paper Collective  
 Grafic art stairs: Kristina Krogh Studio  
 Grafic art small: Paper Colletive

Lamp: Private  
 Brass figure: Glyptoteket  
 Box with stripes: Au Maison  
 Brass tray: Aytm  
 Brass cylinder: Nordstjerne  
 On table:  
 Brass tray: Aytm  
 Jar: Dansk made for Rooms  
 Black ball: Muubs

PAGE 76:  
 From left:  
 Books: Private  
 Pedestal: Private  
 Sculpture: Private  
 On coffee table from the left:  
 Sculpture: Private  
 Marble bowl: Ferm Living  
 Vase: Ferm Living  
 Marble book end: Ferm Living  
 Side table: Woud  
 Table mirror: New Works  
 Books: Private  
 Mobile: Private  
 Floor Lamp: Sacre Coeur

PAGE 80:  
 Mirror: Andrea Larsson Interior  
 Metal basket: Bloomingville  
 Vase: Vintage

Bookend: H&M Home  
 Brass jar: House Doctor  
 Floor lamp: Karkater

PAGE 84:  
 Pictures leaning against the wall: Souvanni  
 Brass figure: Wulffwinding  
 On sofatable:  
 Vase: Lyngby Porcelæn  
 Metal object: Sofie Østerby  
 Books: Privateje  
 Shelf: New Works  
 Marble object on the floor: Sofie Østerby

PAGE 88:  
 From left:  
 Small print: The Poster Club  
 Large print: The Poster Club  
 On table from the left:  
 Sculpture: Private  
 Marble arch: Ferm Living  
 Blue pyramide sculpture: Troels Flensted  
 Jar: H&M Home  
 Books: Private  
 Pedestal: Private  
 Jug: Spring Copenhagen  
 On small side table:  
 Half circle: H&M Home  
 Book end on the floor: Birger1962  
 Books: Private  
 On coffee table:  
 Ball: Private  
 Table lamp: Roomstore  
 Print on floor: The Poster Club

PAGE 90:  
 From the left:  
 Floorlamp: Frandsen Lighting

Painting: Private  
 On coffee table from the left:  
 Half-moon in marble: 101 Cph  
 Ceramic vase: Studio Arhøj)  
 Book: Private  
 Stone sculpture: Ole Mynster Herold  
 As seen on side table from the left:  
 Glass dish: Helle Mardahl  
 Marble chair: Sacre Coeur

PAGE 92:  
 From left:  
 Round object: De Fire Årstider  
 Wooden object: 101 Cph  
 Vase: Anna Bystrup Jensen  
 Photo on the floor: Paper Collective  
 Floor lamp: By Rydens  
 On coffee table:  
 Vase: 101 Cph  
 Vase with Pampas: Tortus Copenhagen  
 Small bowl: Meyer-Lavigne  
 Book: Private  
 Vases on top of pedestal: Tableau-cph

PAGE 94:  
 Art piece on the wall: Sunday-S Gallery  
 On small console table from left:  
 Ceramic cup: Odem Atelier  
 Books: Private  
 On the sofa table from left:  
 Pitcher: Karin Blach Nielsen  
 Small vase: Yonobi  
 Floor lamp: Made by Hand  
 Wooden pillar: Solits  
 Books: Private  
 Sculpture: Private  
 Picture on the wall: Sunday-S Gallery

PAGE 98:  
 Print on floor: Playtype  
 Floor lamp: Lindholdt Studio  
 Side table: Indenfor Udenfor  
 Brass table lamp: Details 91  
 Glass object: House Doctor  
 Art on wall: Retro Villa  
 Carpet: Linie Design

PAGE 100:  
 On table:  
 Vintage lamp: Sacre Coeur  
 Vintage purple glass bowl: To Trin Ned  
 Orange glass vase: Bloomingville  
 Lidded glass container: Bloomingville  
 Carpet: Linie Design  
 Small sofatable: Woud  
 Round object: Jacob Egeberg

PAGE 102:  
 Floor lamp by Michael Anastassiades: Flos  
 Throw: Rabens Aterlier  
 Carpet: Ferm Living  
 On table:  
 Candle holders: Menu  
 Blue tray: Aytm  
 On shelf:  
 Brass table lamp: Karakter  
 Pink jar: Broste  
 Brass vase by Per Sax Møller: Secher Fine Art & Design  
 Pink mirror: Hay  
 Small brass side table: Au Maison  
 Object on side table: Aytm

PAGE 106:  
 Round carpet: Linie Design  
 On sofa table:



Bowl: Roomstore  
 Sideboard: Ikon Cph  
 In window:  
 Lamp: Roomstore  
 Vintage bowl: To Trin Ned  
 Vase with plant: Georg Jensen

## PAGE 110:

Big globe: Kaja Skytte  
 Plaid: Rabens Saloner  
 Marble triangle: H Skjalm P  
 Bowl: Roomstore  
 Grafic art: Private  
 Lamp: Frandsen Lighting  
 On table:  
 Box: Nordstjerne  
 Mirror: Kristina Dam  
 Jar: Dansk Made for Rooms

## PAGE 112:

Jug: Uh La La  
 Cup: Unika K  
 Bulb: Frama  
 Propellers: Fil de Fer  
 Cube: Grid, Montana Group

## PAGE 114:

Sculpture standing on the floor: Troels Flendsted  
 Vase: Yonobi  
 Ceramic pot: Tina Marie Copenhagen  
 Silver cup: Karakter  
 Pictures on the floor: The Poster Club

## PAGE 118

Picture on wall: Private  
 Lamp: Flos  
 On fireplace shelf:  
 Round standing bowl: Notre Dame

Black marble triangle: H Skjalm P  
 Box with stripes: Au Maison  
 Mirror with marble: Notre Dame  
 Brass tray: Bloomingville  
 Marble rings: Kristina Dam  
 Cup on stool: Karakter

## PAGE 120:

Floor lamp: Flos  
 Throw: House Doctor  
 Copper tray with mirror: Bloomingville  
 Jug: House Doctor  
 Copper mirror: Bloomingville  
 Carpet: Ege Tæpper

## PAGE 122:

Black chair: James Stoklund  
 On table:  
 Books: Private  
 Metal cone: James Stoklund  
 Small brass cube: Private  
 Small bowl: Private  
 Black vase: Tortus  
 Wooden ring: Hay  
 Small white vase: Yonobi  
 Sculpture on carpet: Sofie Østerby  
 Floor lamp: Astep  
 Marble plate: Kaja Skytte  
 Bronze sculpture Sonja Ferlov: Galleri Mikael Andersen  
 Painting on the wall: James Stoklund

## PAGE 124:

Picture in frame: Anne Nowak  
 All other things are private

## PAGE 126:

Mirror on legs: Bloomingville

Carpet: Aytm  
 Above the fireplace:  
 Round mirror: Bloomingville  
 Concrete and copper candle holders: New Works  
 On table:  
 Pink jar: Aytm  
 Concrete and copper candle holders: New Works  
 Throw: Rabens Ateriler  
 All other things are private

## PAGE 128:

Jug: Monamore  
 Table: Marrakech Design  
 Lamp: Gubi  
 Painting by Malene Landgreen:  
 Heningensen Gallery

## THANKS TO:

101cph  
 &tradition  
 A Hint of Neon  
 Andrea Larsson Interior  
 Anna Bystrup Jensen  
 Anne Aarsland  
 Anne Nowak  
 Anker & Co  
 Area Store  
 Arket  
 Astep  
 Au Maison  
 Aytm  
 Berit Mogensen Lopez  
 Black Cph  
 Bloomingville  
 Birger1962

Boffi  
 Broste  
 By Rydens  
 Christine Callsen Interieur  
 Czyk  
 Dansk made for Rooms  
 Details 91  
 De Fire Årstider  
 Ebb & Flow  
 Ege Tæpper  
 Ellos Home  
 Etage Projects, Jonas Trapmedach  
 Ferm Living  
 Fenhann  
 Flos  
 Fil de Fer  
 Frama  
 Frandsen Lightning  
 Frou Frou  
 Galleri Mikael Andersen, Sonja Ferlov  
 Georg Jensen  
 Globen Lighting  
 Glyptoteket  
 Grid, Montana Group  
 Gubi  
 H&M Home  
 Handvärk  
 Hanne G  
 Hay  
 Helle Mardahl  
 Heningensen Gallery, Malene Landgreen  
 H Skjalm P  
 House Doctor  
 Idoart  
 Iittala  
 Ikon Cph  
 Indenfor Udenfor  
 Jacob Egeberg

James Stoklund  
 Josphine Alberthe  
 Kaja Skytte  
 Karakter Cph  
 Karin Blach Nielsen  
 Kate Kanstrup  
 Klong  
 Kristina Studio  
 Kristina Dam  
 Kristina Krogh Studio  
 Lindholdt Studio  
 Linie Design  
 Louise Roe  
 Lyngby Porcelæn  
 Madam Stoltz  
 Mater Design  
 Maria Lenskjold  
 Marrakech Design  
 Menu  
 Meyer Lavigne  
 Mintstudio  
 Monamore  
 Munk Collective  
 Muubs

Made by Hand  
 New Works  
 Nordal  
 Nordstjerne  
 Notre Dame  
 Ole Mynster Herold  
 Odem Atelier  
 Ole Wettergren  
 OyOy  
 Paper Collective  
 Playtype  
 Rabens Aterlier  
 Rabens Saloner

RAN keramik  
 Rasmus Fenhann  
 Retro Villa  
 Roomstore, Tom Dixon  
 Rue Verte  
 Rue Verte Plus  
 Roomstore  
 Rug Company  
 Röd Studio  
 Sacre Coeur  
 Secher Fine Art & Design, Per Sax Møller  
 Sigrid Buus  
 Snowdrops Copenhagen by House of Furniture  
 Spring Copenhagen  
 Stilleben  
 Studio Arhøj  
 Socity  
 Sofie Østerby  
 Solits  
 Souvanni  
 Sunday-S Gallery  
 Tableau-cph  
 Tapet Cafe  
 Tasja P. Ceramics  
 The Poster Club  
 Tine K Home  
 Tina Marie Copenhagen  
 To Trin Ned  
 Tortus  
 Trine Birgitte Bond  
 Troels Flendsted  
 Uh La La  
 Unika K  
 Vintage  
 Woud  
 Wulffwinding  
 Yonobi  
 Zik Zak



